

SKITRAB

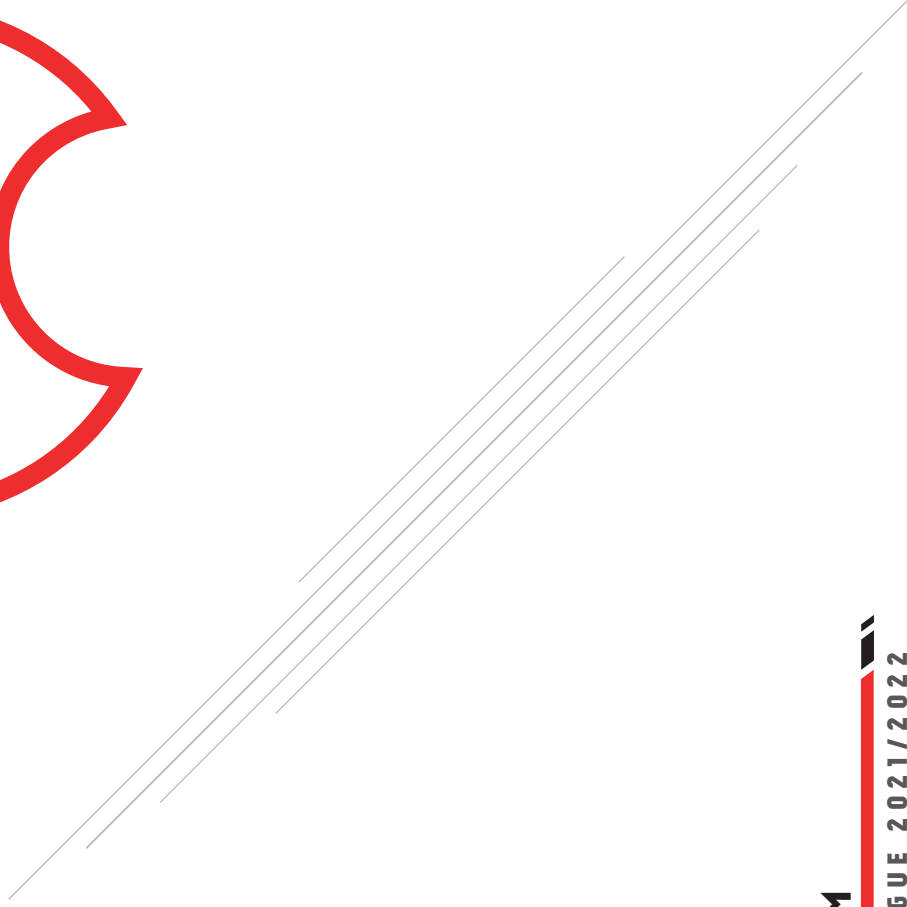

SKITRAB.COM

PRODUCT CATALOGUE 2021/2022



UNA SINTESI DI TRADIZIONE ED INNOVAZIONE TECNOLOGICA

SKI TRAB è nata dall' intuizione e dalla passione di **GIACOMO TRABUCCHI** che nel **1946** costruì i primi sci in legno massiccio. **SKI TRAB** ha la sede produttiva a Bormio, nota stazione turistica, terra di professionisti e campioni. Da allora il costante e naturale contatto con la gente della montagna, ha contribuito allo sviluppo di un prodotto vicino alle vere esigenze degli sciatori. Bormio non è semplicemente il paese di montagna dove vengono prodotti gli sci **SKITRAB**. "Made in Bormio" è un'affermazione che simbolizza un prodotto progettato, sviluppato e costruito da un'Azienda e da Persone che sono attivi esperti in materia di montagna e di scialpinismo. Tutti i prodotti **SKITRAB** si basano sull' esperienza, competenza e conoscenza accumulate in quasi 70 anni di sci, vita e lavoro sulla neve. Skitrab capisce lo sport, lo spirito e la cultura dello sci e lo vive ogni giorno. Vi invitiamo ad unirvi a noi nello scialpinismo e a condividere l'esperienza di sciare con i migliori sci del mondo.

A MIX OF TRADITION AND INNOVATIVE TECHNOLOGY

SKI TRAB started up thanks to **GIACOMO TRABUCCHI'S** intuition and enthusiasm. Trabucchi made his first solid wooden skis in **1946**. The **SKI TRAB** factory is based in Bormio, a renowned skiing resort, boasting a tradition of professionals and champions given to the world of sport. Since its beginning there has always been a constant and natural contact with mountain experts. Bormio it's not simply the mountain village in Italy where **SKITRAB** products are manufactured. "Made in Bormio" is a statement that symbolizes a product that was designed, developed and manufactured by a company and people that are active experts in big mountain and backcountry skiing. All the skitrab products are based on experience, expertise and knowledge we have developed by quite 70 years of skiing, living and working in the snow. **SKITRAB** understands the sport, spirit and culture of skiing and we live it every day. We invite you to join us in the backcountry and to share the experience of skiing on the best skis in the world.



SKITRAB SKIS MADE IN BORMIO

RICERCA

Lo sci viene progettato, costruito, analizzato e testato nella nostra sede di Bormio. Una sofisticata tecnologia per produrre gli sci prototipi e quindi testarli in laboratorio in ogni fase fisica e dinamica.

La nostra sfida maggiore è quella di ripensare lo sci arricchendo il suo codice genetico, dotandolo di innovative tecnologie perchè possa essere semplicemente migliore. L'obiettivo è la sciabilità, non la semplice riduzione del peso. Costruzione a 14 strati, flessione progressiva, anima in aramide, attivo shock absorber, low Omega profile, Duo tail, hibox, affidabilità e cura maniacale per i dettagli sono i fiori all'occhiello di SKI TRAB. Una realtà dove s'incontrano artigianalità e ricerca tecnologica.

RESEARCH

SKI TRAB skis are designed, developed, manufactured and tested in our factory in Bormio. All ski prototypes and moulds are hand-made at SKI TRAB using advanced technology that allows immediate physical, structural and dynamic testing in our world class laboratory.

Our greatest challenge was to redesign the ski, enrich its genetic code, using innovative technology so it can be, simply, better. The aim is ease of skiing, not just a reduction in weight. With 14 layers, progressive flex, an aramid core, ATTIVO shock absorber, DUO tail and combining reliability and scrupulous attention to detail, these skis are the jewel in Ski TRAB's crown: a mix of skilled craftsmanship and scientific research.

TECNOLOGIA IN COSTANTE EVOLUZIONE

La passione per l'innovazione e l'altissima qualità tecnica necessaria per la realizzazione dei nostri progetti rendono necessario un continuo e crescente aggiornamento tecnologico, sia a livello di macchinari impiegati in produzione che a livello di capacità esecutiva da parte del nostro staff. Costruzione a 14 strati, anime realizzate con un complesso mosaico di legno ed aramide, attivo shock absorber, intarsi nelle solette, sono solo alcune delle lavorazioni eseguite che richiedono, nella fase di assemblaggio, grande abilità e bagaglio tecnico non comuni. Le fasi di finitura prima e di controllo della qualità poi necessitano di altrettanta attenzione e tecnologia nonchè di manodopera esperta. Affidabilità e cura maniacale per i dettagli sono i fiori all'occhiello di SKI TRAB, una realtà dove artigianalità e alta tecnologia procedono di pari passo in una costante ricerca di miglioramento.

TECHNOLOGY IN CONSTANT EVOLUTION

Our Passion for innovation and the extremely high quality technology required to carry out our projects make it essential for us to stay ahead of the curve technologically, both in terms of the machines used during the production process and the execution capability of our staff. A 14-layer structure, cores made from a complex mosaic of wood and aramid, active shock absorber, inlays in the base, are just some of the production processes which during the assembly phase require a great deal of ability and a specialist technical background.

The finishing and quality control phases also require just as much attention, technology and skilled manpower.

Reliability and an obsessive attention to detail are what set us apart; at SKI TRAB craftsmanship and cutting-edge technology move forward together in an unending search for improvement.



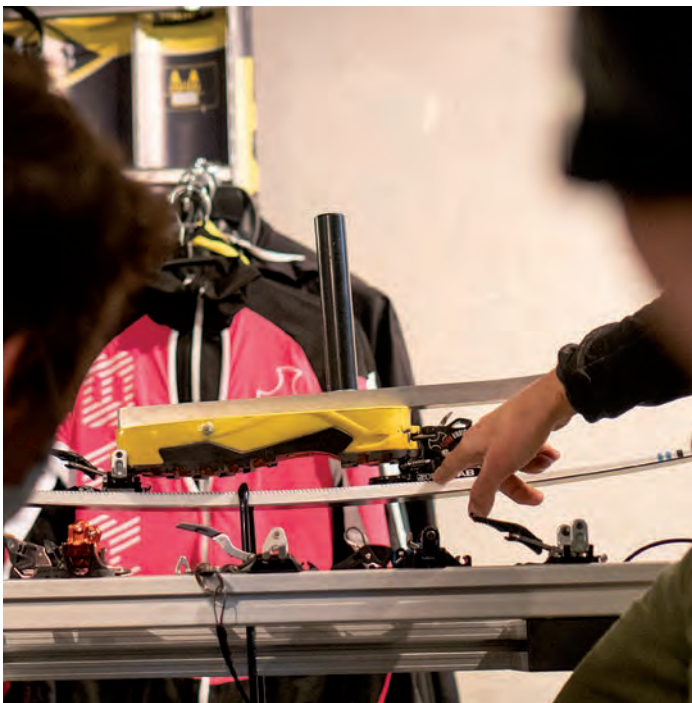

SKITRAB SKIS MADE IN BORMIO

TEST E SVILUPPO

Il costante e naturale contatto con la gente della montagna, dove viviamo e lavoriamo, ha contribuito allo sviluppo di un prodotto sempre più vicino alle esigenze di chi scia. La ricerca tecnologica non avrebbe senso senza la continua evoluzione in atto, possibile solo grazie al supporto dei migliori professionisti della montagna. Così ogni nuova tecnologia nasce dall'idea ben precisa di migliorare la performance, il comfort, di implementare la resistenza ed il divertimento, anche nelle condizioni più difficili. Con noi collaborano infatti i migliori atleti, le guide alpine, e tanti che come noi hanno fatto della sfida e del migliorarsi continuamente il loro obiettivo.

TEST & DEVELOPMENT

Constant contact with people from the mountains, where we live and work, has contributed to the development of a product which matches the demands of skiers. Technological research would be meaningless without constant evolution, only possible thanks to the support of the best mountain professionals. Every new technological breakthrough therefore stems from the clear objective of improving performance, comfort, resistance and fun, even in the most difficult conditions. The best athletes collaborate with us, as well as Alpine Guides and many more who like us are driven by new challenges and a constant desire to improve.

FINITURE

Il successo di uno sci dipende dall'attenzione che si dedica ai particolari. Lo sci SKI TRAB è perfetto in ogni parte, dalla struttura alle finiture. La lavorazione di lamine e solette necessita di tecnologia, metodo e competenza. Doti che fanno la differenza sulla neve. La durata e la scorrevolezza di uno sci dipendono anche dalla qualità e durezza della soletta. In SKI TRAB si usano solamente solette sinterizzate ad alta densità molecolare.

FINISHING

The performance of a ski depends on the attention given to the final finishing details. Each part of a quality ski has to be perfect from the structure to finishing. The processing of the edges and bases requires technology, technique and ability. Skills that are as important in the factory as on the snow. The life, resistance and gliding ability of a ski also depend on the quality and the hardness of the base. SKI TRAB use only high molecular sintered bases.

CONTROLLO QUALITÀ

In SKI TRAB ogni sci è sottoposto ad un accurato e metodico processo di controllo qualità in grado di monitorare ogni singola fase di produzione. SKI TRAB ha dedicato molta attenzione alla formazione del personale e a sensibilizzare gli addetti alla qualità del prodotto. Massima attenzione viene dedicata ad ogni singolo sci. Le aste vengono singolarmente siglate dal team in ogni fase produttiva per garantire un controllo dettagliato.

QUALITY ASSURANCE

At SKI TRAB each ski undergoes a detailed and systematic quality assurance process that monitors quality through each individual phase of production. SKI TRAB has taken great care in training its staff in the methods and understanding of quality assurance and how important it is to build quality into every aspect of our skis. Every SKI TRAB ski is built with pride and attention to detail and is individually initialised by the team that built it.

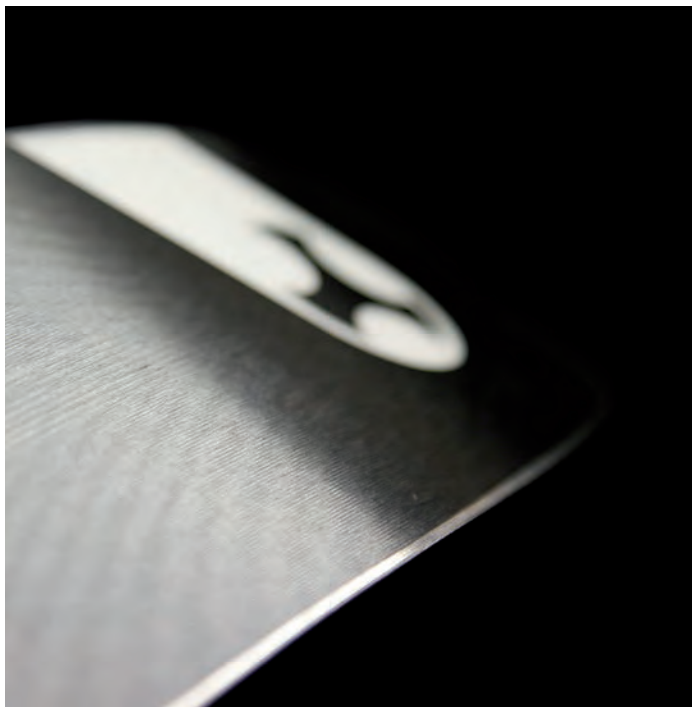



MATHÉO JACQUEMOUD



WOLFGANG HELL



GIULIANO BORDONI



VALENTINE FABRE



BEN TIBBETS



LORENZO HOLZKNECHT



LAETITIA ROUX



FRANÇOIS CAZZANELLI



BRUNO MOTTINI

AMBASSADORS **#SKITRABBER**

- ADRIANO GRECO**
- MERALDI FABIO**
- MARCO CONFORTOLA**
- MARCO TREZZI**
- GIORGIA FELICETTI**
- IVAN PEGORARI**
- GIACOMO MENEGHELLO**
- MANFRED REICHEGGER**
- MATTEO CANOVA**
- SERTORELLI CIRO**
- IACHELINI LORENZO**
- OMAR OPRANDI**
- PLAMEN SHOPSKI**
- FABIO LENTI**
- CIPRIAN LOLU**
- PHILIPP BRUGGER**
- SIGNAR NILSEN**
- BARD SMESTAD**

ATHLETES #SKITRABGARA

MARTIN ANTHAMATTEN
ROBERT ANTONIOLI
JOHANNA ÅSTRØM
VALENTINO BACCA
ROCCO BALDINI
GEORGE BECK
SILVIA BERRA
SAMANTHA BERTOLINA
LÉO BESSON
CAPUCINE BLANC
FANNY BORGSTROM
RICCARDO BOSCACCI
LOUNA BROCHE
ROBIN BUSSARD
THOMAS BUSSARD
NICOLÒ CANCLINI
GIULIA COMPAGNONI
STEFANO CONFORTOLA
DANIELE CORAZZA
MAXIMILIEN DRION
MARC DURR
MARIANNE FATTON
GIORGIA FELICETTI
GASPARD FERRAND
AURÉLIEN GAY
MARTA GARCIA
REMY GARCIN
CORINNA GHIRARDI
NOEMI GIANOLA
NIKOLAY KALISTRIN
HANS INGE KLETTE
VICTORIA KREUZER

MARC RADUA IVERN
PIETRO LANFRANCHI
ARNO LIETHA
RONYA LIETHA
MILAN MADAJ
KATIA MASCHERONA
ADÈLE MILLOZ
LISA MORESCHINI
GIULIA MURADA
SIMONE MURADA
FEDERICO NICOLINI
KIRIL NIKOLOV
DAVID NOVAK
PETR NOVAK
VEGARD ØIE
EKATERINA OSICHKINA
ANTON PALZER
MILAN PISARCIK
PIETRO FESTINI PURLAN
NOÉ ROGIER
ALESSANDRO ROSSI
ERIKA SANELLI
MIRKO SANELLI
ALESSANDRA SCHMIDT
YOANN SERT
MATTEO SOSTIZZO
DIMITRA THEOCHARIS
LUCA TOMASONI
KATIA TOMATIS
JUSTINE TONSO
CAROLINE ULRICH
FLORIAN ULRICH
NICOLE VALLI
ILARIA VERONESE



WORLD CUP WINNERS



GIULIA MURADA



SAMANTHA BERTOLINA

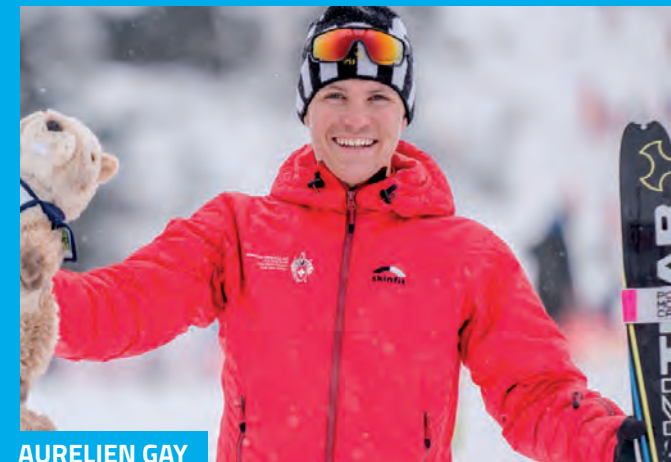

AURELIEN GAY



MARIANNE FATTON



ROBERT ANTONIOLI

SKIS COLLECTION



PURE PERFORMANCE
Ski center size <70 mm



EMOTION AND CONTROL
Ski center size 76+88

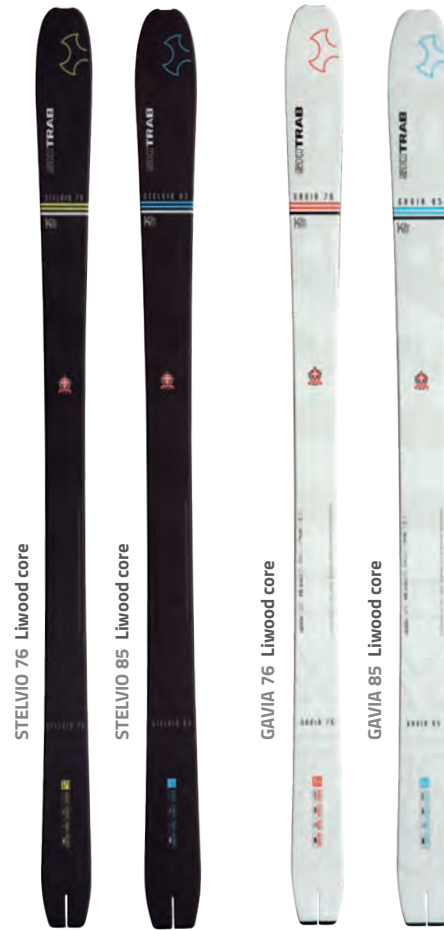

EMOTION AND CONTROL
Ski center size 76+88



ENJOY PURE FREE TOURING
Ski center size >90 mm



RENTAL
Ski center size 76+88

**LIGHT
FASTER
RELIABLE**

PURE PERFORMANCE

14 LAYER
GARA CONTROL

GARA WORLD CUP 70 / GARA WORLD CUP 60 / GARA



 ENGLISH VIDEO

 VIDEO ITALIANO

14 LAYER GARA CONTROL

PURE PERFORMANCE

Il nuovo modello gara di Ski Trab presenta un'inedita geometria allungata. La punta rialzata riduce l'attrito delle pelli in salita e i punti di contatto avanzati e la nuova sciancratura rendono il passo più fluido e dinamico. Entrata in curva immediata ed intuitiva con un assetto che agevola controllo e conduzione unita al miglior galleggiamento favorito da punta e coda più lunghe. Affidabilità garantita dalla costruzione 14 (leggi fourteen) layer gara control, dal carbonio con massima forza anti-torsionale e dallo speciale ponte tra le lamine per reggere meglio agli urti delle pietre. Anima superleggera in alveolare di aramide e legno, nuovi raggi e nuovo flex che migliorano la sciata e riducono il consumo di energia in salita, fondamentale quando la gestione delle risorse è indispensabile. Un' originale coda rastremata facilita e velocizza le operazioni di carico e scarico dello sci dallo zaino.

The new Ski Trab race model debuts a brand-new longer shape. The raised tip reduces the friction of the skins in ascent, while the advanced contact points and the new sidecut make steps more fluid and dynamic. Immediate, intuitive entry into turns with a structure that facilitates control and steering, plus better float thanks to the longer tip and tail.

Reliability is guaranteed by the 14-Layer Gara Control construction wrapped in carbon to maximise the anti-torsion force and by the special bridge between the edges to better withstand impacts with rocks. Superlightweight honeycomb core in aramid and wood, new radiuses and new flex that improves skiing and reduces energy consumption in ascent - fundamental when every little counts.

An original tapered tail makes loading and unloading the ski into your backpack quicker and easier.

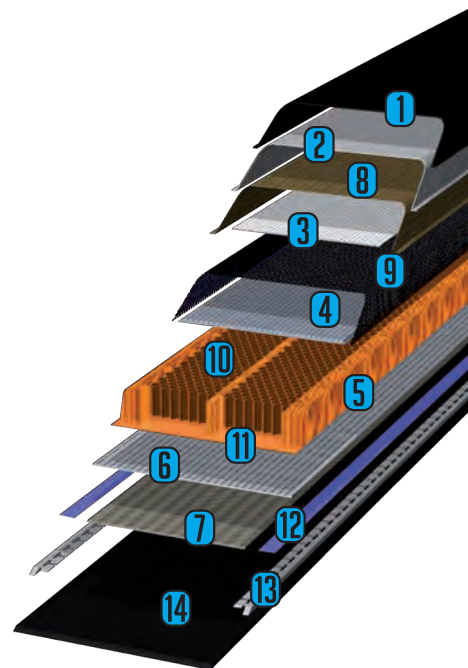

- | | | | |
|--|---|----|-------------------------------------|
| SCRATCH PROOF PA PROTECTION SHELL | 1 | 8 | CARBON FABRIC CAP |
| BIAXIAL CARBON FABRIC CAP | 2 | 9 | CARBON SLEEVE |
| BIAXIAL CARBON FIBER LAMINATE | 3 | 10 | NOMEX HONEYCOMB |
| BINDING REINFORCEMENT ANTITORSIONAL BASE | 4 | 11 | CORE SUPPORT |
| WOODEN SIDEWALL | 5 | 12 | ELASTOMER |
| CARBON FIBER REINFORCEMENT | 6 | 13 | STEEL EDGE HRC 50 +/-2 |
| CARBON SUPPORT | 7 | 14 | HIGH-DENSITY POLYETHYLENE UHMW BASE |

KEY ACHIEVEMENTS

UPHILL IMPROVEMENT

LONGER TIP AND TAIL FOR BETTER FLOATATION

STANDARD

STANDARD

DOWNHILL IMPROVEMENT

NEW MOUNTING POSITION OF THE BINDING BETTER CONTROL

STANDARD

SHIFTED FORWARD

UPHILL IMPROVEMENT

TAPERED TIP GEOMETRY - NEW SHAPE OF TIP AND TAIL FOR A DYNAMIC STRIDE

STANDARD

STANDARD

STANDARD

STANDARD

THE WIDER POINT OF THE TAIL IS SHIFTED FORWARD

THE WIDER POINT OF THE TIP IS SHIFTED FORWARD

UPHILL IMPROVEMENT

RAISED CAMBER LESS CONTACT BETWEEN SKIN AND SNOW WHEN GLIDING UPHILL

STANDARD

UPHILL IMPROVEMENT

TAPERED TAIL EASY TO INSERT INTO YOUR BACKPACK'S SKI CARRY LOOP

TECNOLOGIA ARAMIDE

L'Aramide è una tra le più importanti fibre sintetiche. E' usata nella tecnologia aerospaziale e militare per le incredibili caratteristiche di resistenza.

L'anima alveolare in Aramide rappresenta il miglior rapporto forza/leggerezza oggi sul mercato, SKI TRAB ha scelto il miglior materiale per mantenere alte nel tempo la stabilità, la performance e la durabilità dello sci.

ARAMID TECHNOLOGY

Aramid is among the most important synthetic fibres. It is used in aerospace and military applications due to its incredible resistance features. The Aramid honeycomb compound core represents the best strength/lightweight ratio available today on the market.

SKI TRAB has chosen the best material to obtain long-term high stability, performance and durability of the skis.

THE ARAMID COMPOUND CORE (ARAMID, LIGHT WOOD, ASH) REPRESENTS THE BEST STRENGTH/LIGHTWEIGHT RATIO AVAILABLE TODAY ON THE MARKET

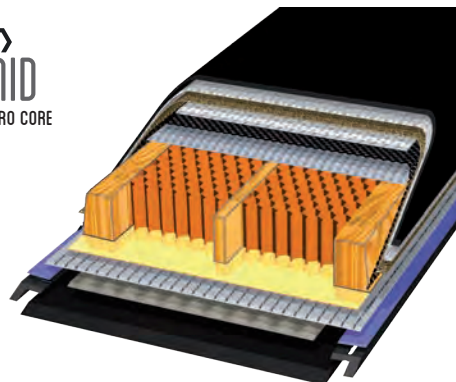

ARAMID / NOMEX

PLACE OF ORIGIN: EUROPE

USE: AEROSPACE AND AERONAUTIC

DENSITY: 70 KG M³

COMPRESSIVE STRENGTH MPA 10

CHARACTERISTICS: LIGHTWEIGHT, FLEXIBLE



LIGHT WOOD

PLACE OF ORIGIN: THE EAST

USE: WOODWORK, SKIS

DENSITY: 270/300 KG M³

COMPRESSIVE STRENGTH MPA 18

CHARACTERISTICS: LIGHTWEIGHT, EASY TO PROCESS



FRAXINUS L. / ASH TREE

PLACE OF ORIGIN: EUROPE

USE: BUILDING INDUSTRY, TOOLS, FUEL

DENSITY: 600/700 KG M³

COMPRESSIVE STRENGTH MPA 30

CHARACTERISTICS: SOLID AND HIGHLY FLEXIBLE

= ULTRALIGHT CORE COMPONENTS

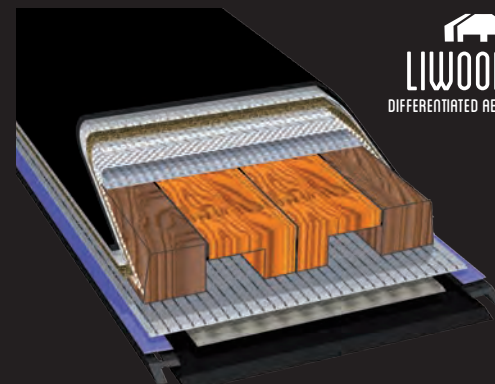

LIWOOD AIR L'EVOLUZIONE DELL'ANIMA IN LEGNO LEGGERO

Lo sci rimane leggero e performante migliorando durata e resistenza. Il legno è la materia prima più usata negli sci. Da anni si è alla ricerca del legno leggero ma allo stesso tempo lo si vorrebbe duraturo e forte. Si va contro natura. L'anima in legno leggero deve essere supportata da lavorazioni e accoppiamenti con altri legni per migliorare la forza e soprattutto aiutata da materiali in composito che avvolgendola danno rigidità torsionale e durabilità. I canali d'aria appositamente inseriti rendono lo sci più leggero senza compromettere la struttura.

LIWOOD AIR THE EVOLUTION OF THE LIGHTWEIGHT WOOD CORE

Wood is the most used raw material in ski production. For years designers have sought after a wood that is lightweight yet durable and strong, yet this goes against nature. A lightweight wood core needs to be supported by production processes and to be mixed with other types of wood to improve its strength; above all it must be wrapped by composite materials which give it torsional rigidity and durability. The air ducts make the ski lighter without compromising the structure. The light wood and hard wood compound core represents the best SOLUTION available for SKI TOURING today on the market.

LIGHT WOOD

HARD WOOD

THE LIGHT WOOD AND HARD WOOD COMPOUND CORE REPRESENTS THE BEST SOLUTION AVAILABLE FOR SKI TOURING TODAY ON THE MARKET.

LIGHT WOOD

PLACE OF ORIGIN: THE EAST

USE: WOODWORK, SKIS

DENSITY: 270/300 KG M³

COMPRESSIVE STRENGTH MPA 18

CHARACTERISTICS: LIGHTWEIGHT, EASY TO PROCESS



FRAXINUS L. / ASH TREE

PLACE OF ORIGIN: EUROPE

USE: BUILDING INDUSTRY, TOOLS, FUEL

DENSITY: 600/700 KG M³

COMPRESSIVE STRENGTH MPA 30

CHARACTERISTICS: SOLID AND HIGHLY FLEXIBLE

= LIWOOD AIR CORE



GARA CONTROL FLEX

La costruzione e la tecnologia a 14 strati SKI TRAB permettono di ottenere un flex molto morbido alle estremità dello sci che lo rende facile e maneggevole. La punta rialzata facilita lo scorrimento in salita ed il conseguente risparmio di energie. In zona centrale lo sci è più sostenuto con un'importante rigidità torsionale ed un ottimo controllo degli spigoli, garanzia su neve dura e ghiacciata.

GARA CONTROL FLEX

The construction and Ski Trab 14-layer technology allow for a very soft flex at the tips and tails of the ski that makes it easily manageable. The raised tip facilitates glide in ascent and saves energy as a result. In the centre the ski has more support with a high level of torsional rigidity and excellent control of the edges, ideal on hard, icy snow.



HIBOX CONTROLLO TORSIONE

Gabbia di carbonio a trama molto sottile (3k) che avvolge internamente lo sci, conferendogli una rigidità torsionale decisamente superiore (fino al 46%). Questo tipo di lavorazione va a beneficio della sola struttura antitorsione, senza penalizzare i valori di flessione dello sci.

HIBOX TORSION CONTROL

Thin micro-mesh carbon cage (3k) which wraps around the ski providing a definitely higher torsional stiffness (up to 46%). This type of processing aims at giving benefits only to the antitorsional structure without compromising the bending values of the skis.



DUO TAIL FLESSIBILITÀ DIFFERENZIATA

1. con lo sci piatto la coda mantiene una rigidità che garantisce perfetta stabilità e sostegno.
2. in curva la flessibilità della coda è maggiore migliorando la chiusura di curva e la facilità della sciata.
3. quando lo sci è piatto il taglio della coda migliora la stabilità direzionale.

DUO TAIL DIFFERENT FLEXIBILITY

1. with a flat ski the tail maintains its rigidity and the ski guarantees a perfect stability and support.
2. on turning the tail flexibility is greater, improving the steering and making skiing easier.
3. with a flat ski the hollow of the ski tail increases stability and steering precision.

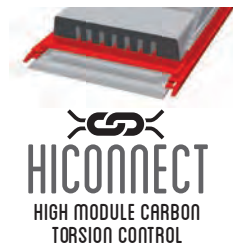

HICONNECT COLLEGAMENTO TRA LE LAMINE ESTREMAMENTE RESISTENTE

Per mantenere alta nel tempo la planarità abbiamo realizzato un ponte che collega le due lamine internamente, in maniera tale da renderle un tutt'uno difficile da disassare. Questa speciale costruzione permette di tenere le lamine in sede anche dopo impatti importanti con rocce o altro.

HICONNECT STRONG EDGE TO EDGE CONNECTION

In order to maintain the flatness of the ski over time we have designed a bridge that connects the two edges internally, in such a way that it is almost impossible to misalign.

This special construction means that the edges stay where they should be, even after multiple impacts with hard surfaces like rocks.



NO SHOCK, CONTROLLO ATTIVO DELLE VIBRAZIONI

Una striscia di elastomero speciale viene posta longitudinalmente tra le lamine e la struttura interna dello sci. In punta ed in coda l'elastomero copre tutta la superficie dello sci. L'inserimento di questo elemento crea una sorta di ammortizzazione che rende lo sci più stabile e più lineare nella risposta agli stimoli impressi.

NO SHOCK, ACTIVE VIBRATION CONTROL

A band of a special elastomer is placed lengthways between the edges and the internal structure of the ski. At the tip and the tail, the elastomer covers the entire surface of the ski. Its addition creates a cushioning effect that makes the ski more stable and more linear in response to external factors.

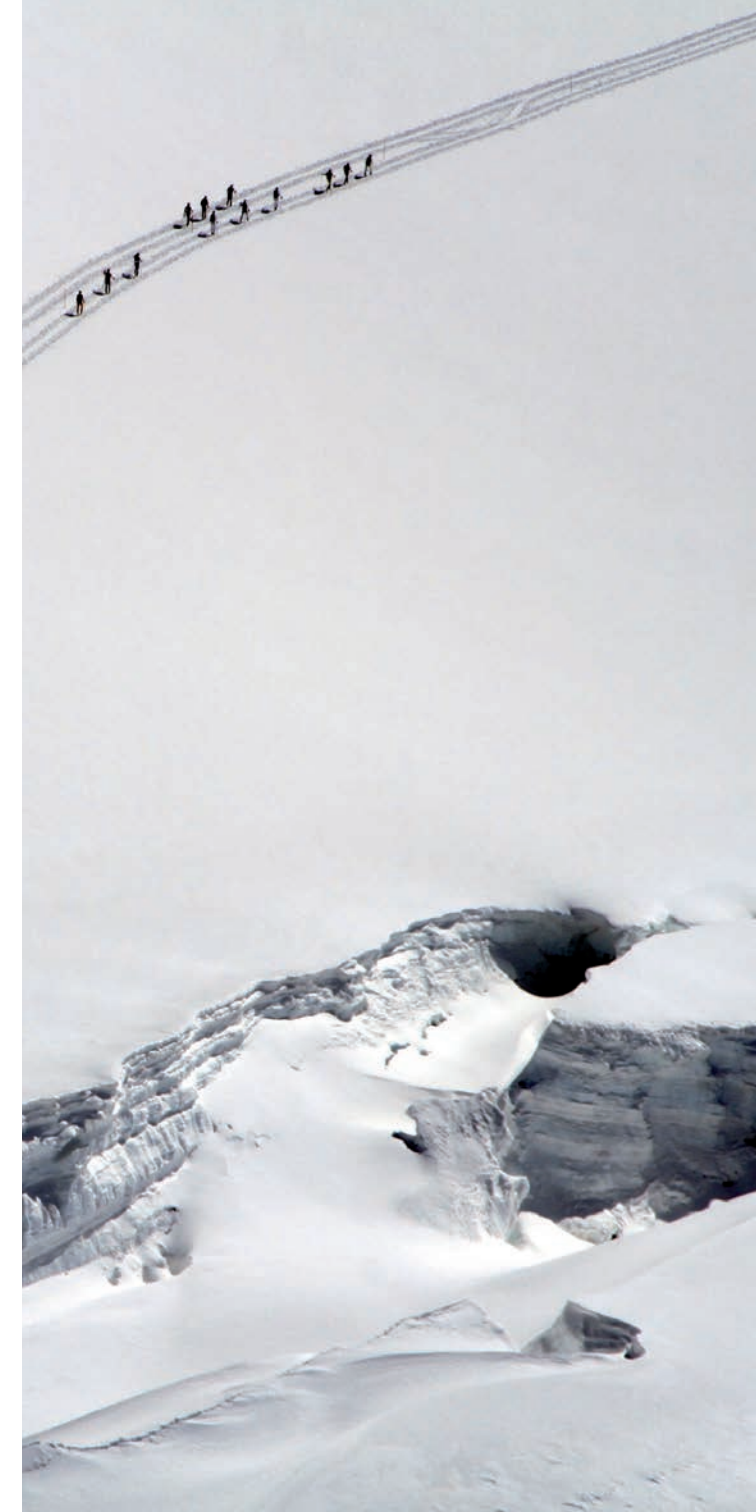

GARA WORLD CUP 70 cod. 13176



Reliability is guaranteed by the 14-Layer Gara Control construction wrapped in carbon to maximise the anti-torsion force and by the special bridge between the edges to better withstand impacts with rocks. Superlightweight honeycomb core in aramid and wood, new radiuses and new flex 70 that improves skiing and reduces energy consumption in ascent - fundamental when every little counts.

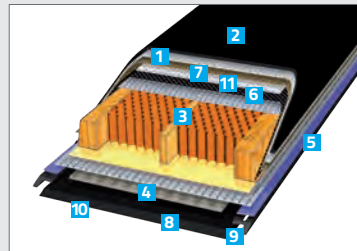

- 1 CONSTRUCTION: CAP QUADRIAXIAL
- 2 PROTECTION SHEET: PA LIGHT PROTECTION
- 3 CORE: ARAMID-ASH WOOD-LIGHT WOOD
- 4 CARBON SUPPORT: BIAXIAL CARBON
- 5 EDGE: STEEL 52HRC
- 6 TORSION REINFORCEMENTS: CARBON HM
- 7 CAP REINFORCEMENT: CARBON-BASALT
- 8 BASE: SINTERED BLACK BASE
- 9 FINISHING: EDGE RADIAL - TUNING 89°
- 10 BASE FINISHING: RACE MICROSTRUCTURED
- 11 BINDING PLATE/ANTI-TORSIONAL PLATE: MULTI LAYER FIBERGLASS



SIZE (CM)	162	169
WEIGHT(GR)	715	745
RADIUS(MT)	23.6	24.8
SURFACE(CM2)	1164	12 06
TORSION	CARBON	CARBON
SIDECUT(MM)	92/64/79	92/63/79



ENGLISH VIDEO

VIDEO ITALIANO



GARA WORLD CUP 60 cod. 13175



Reliability is guaranteed by the 14-Layer Gara Control construction wrapped in carbon to maximise the anti-torsion force and by the special bridge between the edges to better withstand impacts with rocks. Superlightweight honeycomb core in aramid and wood, new radiuses and new flex 60 that improves skiing and reduces energy consumption in ascent - fundamental when every little counts.

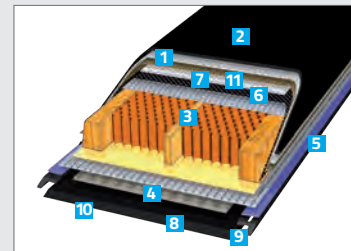

- 1 CONSTRUCTION: CAP QUADRIAXIAL
- 2 PROTECTION SHEET: PA LIGHT PROTECTION
- 3 CORE: ARAMID-ASH WOOD-LIGHT WOOD
- 4 CARBON SUPPORT: BIAXIAL CARBON
- 5 EDGE: STEEL 52HRC
- 6 TORSION REINFORCEMENTS: CARBON HM
- 7 CAP REINFORCEMENT: CARBON-BASALT
- 8 BASE: SINTERED BLACK BASE
- 9 FINISHING: EDGE RADIAL - TUNING 89°
- 10 BASE FINISHING: RACE MICROSTRUCTURED
- 11 BINDING PLATE/ANTI-TORSIONAL PLATE: MULTI LAYER FIBERGLASS



SIZE (CM)	162
WEIGHT(GR)	705
RADIUS(MT)	23.6
SURFACE(CM2)	1164
TORSION	CARBON
SIDECUT(MM)	92/64/79



ENGLISH VIDEO

VIDEO ITALIANO



GARA WORLD CUP 60 cod. 13175w



Reliability is guaranteed by the 14-Layer Gara Control construction wrapped in carbon to maximise the anti-torsion force and by the special bridge between the edges to better withstand impacts with rocks. Superlightweight honeycomb core in aramid and wood, new radiuses and new flex 60 that improves skiing and reduces energy consumption in ascent - fundamental when every little counts.

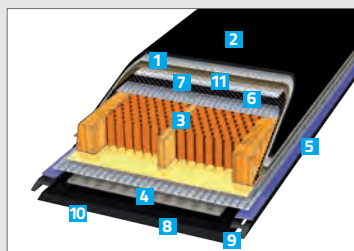

- 1 CONSTRUCTION: CAP QUADRIAXIAL
- 2 PROTECTION SHEET: PA LIGHT PROTECTION
- 3 CORE: ARAMID-ASH WOOD-LIGHT WOOD
- 4 CARBON SUPPORT: BIAXIAL CARBON
- 5 EDGE: STEEL 52HRC
- 6 TORSION REINFORCEMENTS: CARBON HM
- 7 CAP REINFORCEMENT: CARBON-BASALT
- 8 BASE: SINTERED BLACK BASE
- 9 FINISHING: EDGE RADIAL - TUNING 89°
- 10 BASE FINISHING: RACE MICROSTRUCTURED
- 11 BINDING PLATE/ANTI-TORSIONAL PLATE: MULTI LAYER FIBERGLASS



SIZE (CM)	155
WEIGHT(GR)	685
RADIUS(MT)	21,3
SURFACE(CM2)	1113
TORSION	CARBON
SIDECUT(MM)	92/64/79



ENGLISH VIDEO

VIDEO ITALIANO



GARA cod. 13177



Reliability is guaranteed by the 14-Layer Gara Control construction wrapped in carbon to maximise the anti-torsion force and by the special bridge between the edges to better withstand impacts with rocks. Superlightweight liwood core in hard wood and light wood, new radiuses and new flex that improves skiing and reduces energy consumption in ascent - fundamental when every little counts.

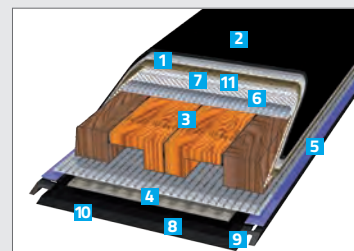

- 1 CONSTRUCTION: CAP QUADRIAXIAL
- 2 PROTECTION SHEET: PA LIGHT PROTECTION
- 3 CORE: HARD WOOD-LIGHT WOOD
- 4 CARBON SUPPORT: BIAXIAL CARBON
- 5 EDGE: STEEL 52HRC
- 6 TORSION REINFORCEMENTS: CARBON HM
- 7 CAP REINFORCEMENT: CARBON-BASALT
- 8 BASE: SINTERED BLACK BASE
- 9 FINISHING: EDGE RADIAL - TUNING 89°
- 10 BASE FINISHING: RACE MICROSTRUCTURED
- 11 BINDING PLATE/ANTI-TORSIONAL PLATE: MULTI LAYER FIBERGLASS



SIZE (CM)	155	162	169
WEIGHT(GR)	730	760	795
RADIUS(MT)	21,3	23,6	24,8
SURFACE(CM2)	1113	1164	12 06
TORSION	CARBON -GLASS	CARBON -GLASS	CARBON -GLASS
SIDECUT(MM)	92/64/79	92/64/79	92/63/79



ENGLISH VIDEO

VIDEO ITALIANO



**DIFFERENT
STYLES
ONE GOAL**

EMOTION AND CONTROL



MAESTRO.2 / MAGICO.2 / ORTLES / BERNINA / STELVIO / GAVIA



14 LAYER CONTROL

EMOTION AND CONTROL

Emozione e controllo sono i valori a cui si ispira l'ultimo progetto skitrab. Per coniugarli abbiamo sviluppato la tecnologia 14 layer control dove alla consolidata costruzione 14 strati si affianca una nuova e moderna concezione dello sci. L'anima, realizzata con legno o aramide, è supportata dalle lavorazioni in composito e dalle tecnologie ad alta stratificazione che conferiscono rigidità torsionale e durabilità, oltre alla nota leggerezza. Punta e coda più lunghe garantiscono un maggior galleggiamento e la loro diversa forma migliora ingresso ed uscita di curva. I nuovi raggi ed il baricentro spostato in avanti con un nuovo tipo di flex danno allo sci un assetto che favorisce il controllo e la performance in discesa. Trova il tuo sci tra 7 modelli con caratteristiche e misure diverse. Differenti stili per un obiettivo comune: emozione e controllo.

Emotion and control are the values that have inspired the latest Ski Trab project. Emotion in the sense of sheer thrill in descent, control for better precision when skiing. To combine the two we have developed 14-Layer Control Technology where the tried and tested 14-layer construction joins with a new and modern concept of the ski. The core, made from wood and aramid, is supported by composite materials and high stratification technologies that confer torsional rigidity and durability, as well as being famously light in weight. A longer tip and tail guarantee better float and their different shape improves entry into and exit from turns. The new radiuses and the movement of the barycentre further forward, together with a new type of flex give the ski a distribution that favours control and performance in descent. Maestro: 76 mm, Magico, 85 mm. Different styles with a common goal: emotion and control.

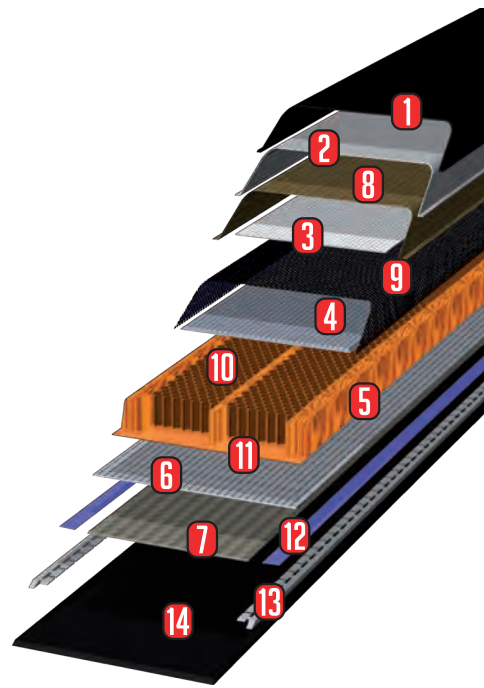

- SCRATCH PROOF PA PROTECTION SHELL **1** CARBON/GLASS-CARBON FABRIC CAP **8**
- BIAXIAL CARBON FABRIC CAP **2** CARBON SLEEVE **9**
- BIAXIAL CARBON FIBER LAMINATE **3** NOMEX HONEYCOMB **10**
- BINDING REINFORCEMENT ANTITORSIONAL BASE **4** CORE SUPPORT **11**
- WOODEN SIDEWALL **5** ELASTOMER **12**
- CARBON/GLASS-CARBON REINFORCEMENT **6** STEEL EDGE HRC 58 +/-2 **13**
- CARBON/GLASS-CARBON SUPPORT **7** HIGH-DENSITY POLYETHYLENE UHMW BASE **14**

KEY ACHIEVEMENTS

DOWNHILL IMPROVEMENT

NEW FLEX AT TIP AND TAIL FOR BETTER CONTROL

STANDARD 14 LAYER CONTROL

DOWNHILL IMPROVEMENT

NEW MOUNTING POSITION OF THE BINDING FOR BETTER CONTROL

STANDARD SHIFTED 25 MM FORWARD

DOWNHILL IMPROVEMENT

NEW TAIL SHAPE TO IMPROVE EASY TURNING

NEW SHIN FIXING SYSTEM

DOWNHILL IMPROVEMENT

LONGER TIP AND TAIL FOR BETTER FLOATATION

>100% >39%

DOWNHILL IMPROVEMENT

NEW SHAPE OF TIP AND TAIL FOR BETTER STEERING

THE WIDER POINT OF THE TIP IS SHIFTED 57% FORWARD THE WIDER POINT OF THE TAIL IS SHIFTED 58% FORWARD

DOWNHILL IMPROVEMENT

3 NEW SIDECUT RADIUS FOR BETTER ADAPTABILITY

R1 17 MT R2 21 MT R3 24 MT

TECNOLOGIA ARAMIDE

L'Aramide è una tra le più importanti fibre sintetiche. E' usata nella tecnologia aerospaziale e militare per le incredibili caratteristiche di resistenza.

L'anima alveolare in Aramide rappresenta il miglior rapporto forza/leggerezza oggi sul mercato, SKI TRAB ha scelto il miglior materiale per mantenere alte nel tempo la stabilità, la performance e la durabilità dello sci.

ARAMID TECHNOLOGY

Aramid is among the most important synthetic fibres. It is used in aerospace and military applications due to its incredible resistance features. The Aramid honeycomb compound core represents the best strength/lightweight ratio available today on the market.

SKI TRAB has chosen the best material to obtain long-term high stability, performance and durability of the skis.

THE ARAMID COMPOUND CORE (ARAMID, LIGHT WOOD, ASH) REPRESENTS THE BEST STRENGTH/LIGHTWEIGHT RATIO AVAILABLE TODAY ON THE MARKET

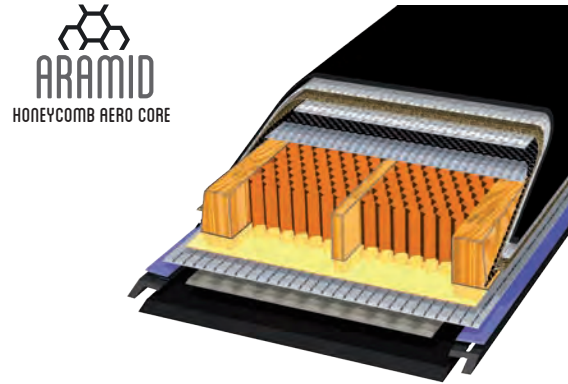

= ULTRALIGHT CORE COMPONENTS

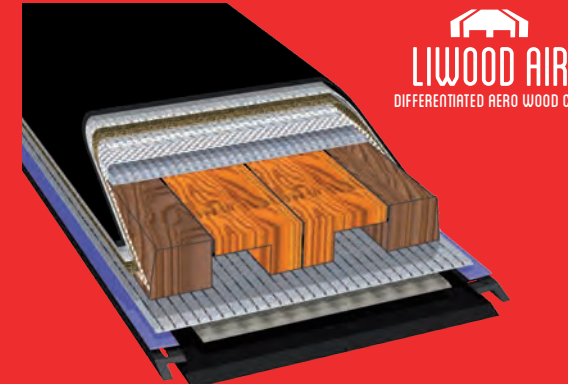

THE LIGHT WOOD AND HARD WOOD COMPOUND CORE REPRESENTS THE BEST SOLUTION AVAILABLE FOR SKI TOURING TODAY ON THE MARKET.



= LIWOOD AIR CORE

LIWOOD AIR L'EVOLUZIONE DELL'ANIMA IN LEGNO LEGGERO

Lo sci rimane leggero e performante migliorando durata e resistenza. Il legno è la materia prima più usata negli sci. Da anni si è alla ricerca del legno leggero ma allo stesso tempo lo si vorrebbe duraturo e forte. Si va contro natura. L'anima in legno leggero deve essere supportata da lavorazioni e accoppiamenti con altri legni per migliorare la forza e soprattutto aiutata da materiali in composito che avvolgendola danno rigidità torsionale e durabilità. I canali d'aria appositamente inseriti rendono lo sci più leggero senza compromettere la struttura.

LIWOOD AIR THE EVOLUTION OF THE LIGHTWEIGHT WOOD CORE

Wood is the most used raw material in ski production. For years designers have sought after a wood that is lightweight yet durable and strong, yet this goes against nature. A lightweight wood core needs to be supported by production processes and to be mixed with other types of wood to improve its strength; above all it must be wrapped by composite materials which give it torsional rigidity and durability. The air ducts make the ski lighter without compromising the structure. The light wood and hard wood compound core represents the best SOLUTION available for SKI TOURING today on the market.



CONTROL PROGRESSIVE FLEX

Il flex di uno sci ed il relativo abbinamento ai raggi di sciancratura fanno la differenza. La costruzione e la tecnologia a molti strati SKI TRAB permettono di ottenere un flex molto morbido alle estremità dello sci. Lo sci risulta facile e maneggevole e si adatta facilmente alle nevi che incontra. In zona centrale lo sci è più sostenuto, offre un'importante rigidità torsionale ed un ottimo controllo degli spigoli con una garanzia di ottima presa su neve dura e ghiacciata. Nella zona più arretrata lo sci ha un flex più accentuato e permette in fase di carico di far lavorare maggiormente il raggio dello sci migliorandone la conducibilità ed il controllo. La zona di montaggio è stata avanzata in modo da migliorare l'assetto sullo sci.

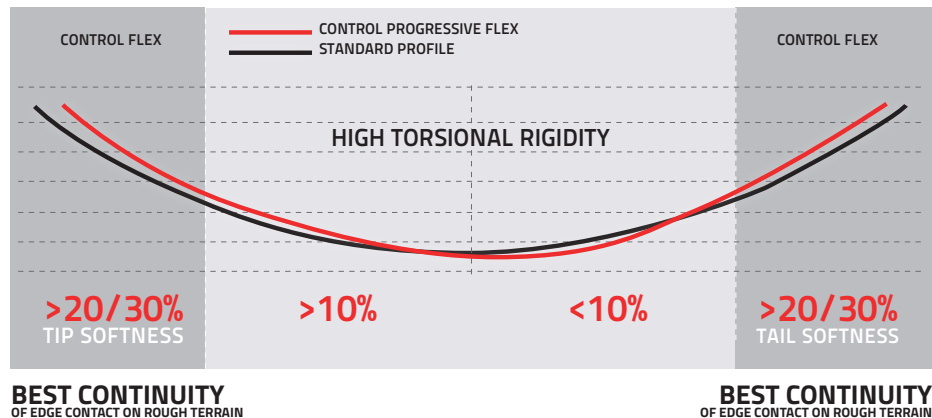

The flex of a ski in relation to the radius of the sidecut makes all the difference. The construction and the multi-layer Ski Trab technology allow for a very soft flex at the very ends of the ski, making it easy to use and manageable, adapting effortlessly to all types of snow. At its centre the ski is firmer, offering good torsional rigidity and excellent edge control, guaranteeing good grip on hard, icy snow. Towards the back of the ski the flex is more accentuated, so that during the loading phase the radius of the ski works more to improve steering and control. The mounting has been moved forward in order to improve the trim of the ski.



DUO TAIL FLESSIBILITÀ DIFFERENZIATA

1. con lo sci piatto la coda mantiene una rigidità che garantisce perfetta stabilità e sostegno.
2. in curva la flessibilità della coda è maggiore migliorando la chiusura di curva e la facilità della sciata.
3. quando lo sci è piatto il taglio della coda migliora la stabilità direzionale.

DUO TAIL DIFFERENT FLEXIBILITY

1. with a flat ski the tail maintains its rigidity and the ski guarantees a perfect stability and support.
2. on turning the tail flexibility is greater, improving the steering and making skiing easier.
3. with a flat ski the hollow of the ski tail increases stability and steering precision.

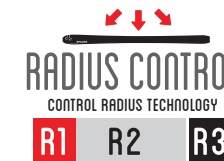

RADIUS CONTROL

I raggi hanno la funzione abbinata al flex di condurre lo sciatore in fase di curva. Un'innovativa correlazione con flex e raggi facilita l'entrata in curva e migliora il controllo e la conduzione dello sci in uscita di curva.

The radius, along with the flex, help to drive the skier into a turn. An innovative correlation between flex and radius facilitates entry into the turn and improves control and exit from the turn.



+46%

HIBOX CONTROLLO TORSIONE

Gabbia di carbonio a trama molto sottile (3k) che avvolge internamente lo sci, conferendogli una rigidità torsionale decisamente superiore (fino al 46%). Questo tipo di lavorazione va a beneficio della sola struttura antitorsione, senza penalizzare i valori di flessione dello sci.

HIBOX TORSION CONTROL

Thin micro-mesh carbon cage (3k) which wraps around the ski providing a definitely higher torsional stiffness (up to 46%). This type of processing aims at giving benefits only to the antitorsional structure without compromising the bending values of the skis.



ACTIVE SHOCK ABSORBER

Elementi di polimero strutturale inseriti in senso longitudinale sui fianchi superiori dello sci. Hanno la funzione di assorbire le vibrazioni e dare stabilità allo sci. Inoltre svolgono un'importante protezione della struttura evitando che lo sci sia danneggiato da colpi e tagli che potrebbero facilmente intaccare gli spigoli e aprire la struttura interna.

Structural polymer components are integrated lengthwise on the top sides of the skis. Their function is to absorb the vibrations providing an enhanced stability to the skis. They also play an important role in protecting the structure by preventing the skis to be ruined by blows or cuts which might easily damaged the edges and open the internal structure.



HICONNECT COLLEGAMENTO TRA LE LAMINE ESTREMAMENTE RESISTENTE

Per mantenere alta nel tempo la planarità abbiamo realizzato un ponte che collega le due lamine internamente, in maniera tale da renderle un tutt'uno difficile da disassare. Questa speciale costruzione permette di tenere le lamine in sede anche dopo impatti importanti con rocce o altro.

HICONNECT STRONG EDGE TO EDGE CONNECTION

In order to maintain the flatness of the ski over time we have designed a bridge that connects the two edges internally, in such a way that it is almost impossible to misalign. This special construction means that the edges stay where they should be, even after multiple impacts with hard surfaces like rocks.



NO SHOCK, CONTROLLO ATTIVO DELLE VIBRAZIONI

Una striscia di elastomero speciale viene posta longitudinalmente tra le lamine e la struttura interna dello sci. In punta ed in coda l'elastomero copre tutta la superficie dello sci. L'inserimento di questo elemento crea una sorta di ammortizzazione che rende lo sci più stabile e più lineare nella risposta agli stimoli impressi.

NO SHOCK, ACTIVE VIBRATION CONTROL

A band of a special elastomer is placed lengthways between the edges and the internal structure of the ski. At the tip and the tail, the elastomer covers the entire surface of the ski. Its addition creates a cushioning effect that makes the ski more stable and more linear in response to external factors.

MAESTRO.2 cod. 13178

4 LAYER CONTROL

Maestro.2 is the more technical model, lightweight and powerful for large height differences! The core, made from wood and aramid, is supported by composite materials and high stratification technologies that confer torsional rigidity and durability. Immediate, intuitive entry into turns with a structure that facilitates control and steering, thanks to new radiuses, a shape with longer tips and tails, the movement of the barycentre further forward and a progressive flex with maximum torsional rigidity.

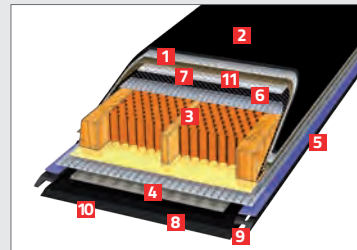

- 1 CONSTRUCTION: CAP QUADRIAXIAL
- 2 PROTECTION SHEET: PA LIGHT PROTECTION
- 3 CORE: ARAMID-ASH WOOD-LIGHT WOOD
- 4 FIBERGLASS SUPPORT: BIAXIAL FIBERGLASS
- 5 EDGE: STEEL 52HRC
- 6 TORSION REINFORCEMENTS: CARBON HM
- 7 CAP REINFORCEMENT: CARBON-BASALT
- 8 BASE: SINTERED BLACK BASE
- 9 FINISHING: EDGE RADIAL - TUNING 89°
- 10 BASE FINISHING: RACE MICROSTRUCTURED
- 11 BINDING PLATE/ANTI-TORSIONAL PLATE: MULTI LAYER FIBERGLASS

ARAMID
HONEYCOMB AERO CORE

SIZE (CM)	157	164	171	178
WEIGHT(GR)	910	925	953	1000
RADIUS(MT)	20,50	21,70	22	24,10
SURFACE(CM2)	1369	1420	1461	1519
TORSION	CARBON	CARBON	CARBON	CARBON
SIDECUT(MM)	108/79/94	108/78/94	108/76/94	108/76/94



ENGLISH VIDEO

VIDEO ITALIANO



ATTIVO CONTROL FLEX DUOTAIL HIBOX HICONNECT NOSHOCK RADIUS CONTROL

MAGICO.2 cod. 13179

4 LAYER CONTROL

Magico.2: powerful, technical and lightweight - the best combination of ascent and descent. The core, made from wood and aramid, is supported by composite materials and high stratification technologies that confer torsional rigidity and durability. Immediate, intuitive entry into turns with a structure that facilitates control and steering, thanks to new radiuses, a shape with longer tips and tails to provide better float, the movement of the barycentre further forward and a progressive flex with maximum torsional rigidity.

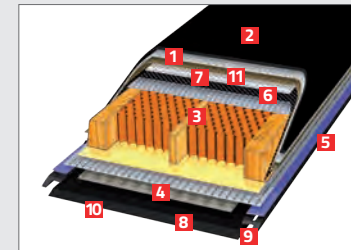

- 1 CONSTRUCTION: CAP QUADRIAXIAL
- 2 PROTECTION SHEET: PA LIGHT PROTECTION
- 3 CORE: ARAMID-ASH WOOD-LIGHT WOOD
- 4 FIBERGLASS SUPPORT: BIAXIAL FIBERGLASS
- 5 EDGE: STEEL 52HRC
- 6 TORSION REINFORCEMENTS: CARBON HM
- 7 CAP REINFORCEMENT: CARBON-BASALT
- 8 BASE: SINTERED BLACK BASE
- 9 FINISHING: EDGE RADIAL - TUNING 89°
- 10 BASE FINISHING: RACE MICROSTRUCTURED
- 11 BINDING PLATE/ANTI-TORSIONAL PLATE: MULTI LAYER FIBERGLASS

ARAMID
HONEYCOMB AERO CORE

SIZE (CM)	157	164	171	178
WEIGHT(GR)	1000	1032	1055	1100
RADIUS(MT)	19,50	20,08	21,10	23,10
SURFACE(CM2)	1511	1569	1616	1682
TORSION	CARBON	CARBON	CARBON	CARBON
SIDECUT(MM)	118/88/104	118/87/104	118/85/104	118/85/104



ENGLISH VIDEO

VIDEO ITALIANO



ATTIVO CONTROL FLEX DUOTAIL HIBOX HICONNECT NOSHOCK RADIUS CONTROL

ORTLES cod. 13169



Ortles offers the best downhill performance of the line. It is perfect for demanding skiers with a good level of technical skill. The core is made with Liwood air and 14-layer technologies guaranteeing excellent reliability and low weight. Control progressive flex, hiconnect and no shock active vibration control for safe, precise turns. The ideal ski for those looking for equipment that instantly responds to the commands of the skier.

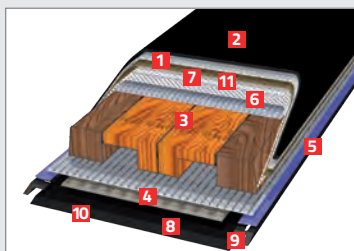

- 1 CONSTRUCTION: CAP QUADRIAXIAL
- 2 PROTECTION SHEET: PA STRONG PROTECTION
- 3 CORE: HARD WOOD-LIGHT WOOD
- 4 FIBERGLASS SUPPORT: BIAXIAL FIBERGLASS
- 5 EDGE: STEEL 52HRC
- 6 TORSION REINFORCEMENTS: CARBON HM
- 7 CAP REINFORCEMENT: CARBON-BASALT
- 8 BASE: SINTERED BLACK BASE
- 9 FINISHING: EDGE RADIAL - TUNING 89°
- 10 BASE FINISHING: MICROSTRUCTURED
- 11 BINDING PLATE/ANTI-TORSIONAL PLATE: MULTI LAYER FIBERGLASS



SIZE (CM)	157	164	171	178
WEIGHT(GR)	1010	1055 g	1100	1160
RADIUS(MT)	19,50	20,08	21,10	23,10
SURFACE(CM2)	1511	1569	1616	1682
TORSION	CARBON	CARBON	CARBON	CARBON
SIDECUT(MM)	118/88/104	118/87/104	118/85/104	118/85/104



ENGLISH VIDEO

VIDEO ITALIANO



BERNINA cod. 13181



Bernina offers the best downhill performance of the line. It is perfect for demanding skiers with a good level of technical skill, for lighter skiers or for those looking for softer and more manageable skis. The core is made with Liwood air and 14-layer technologies guaranteeing excellent reliability and low weight. Control progressive flex, hiconnect and no shock active vibration control for safe, precise turns. The ideal ski for those looking for equipment that instantly responds to the commands of the skier.

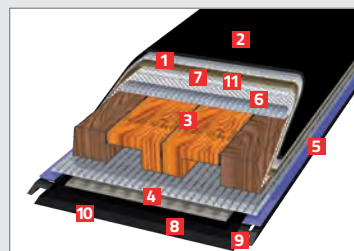

- 1 CONSTRUCTION: CAP QUADRIAXIAL
- 2 PROTECTION SHEET: PA STRONG PROTECTION
- 3 CORE: HARD WOOD-LIGHT WOOD
- 4 FIBERGLASS SUPPORT: BIAXIAL FIBERGLASS
- 5 EDGE: STEEL 52HRC
- 6 TORSION REINFORCEMENTS: CARBON HM
- 7 CAP REINFORCEMENT: GLASS-BASALT
- 8 BASE: SINTERED BLACK BASE
- 9 FINISHING: EDGE RADIAL - TUNING 89°
- 10 BASE FINISHING: MICROSTRUCTURED
- 11 BINDING PLATE/ANTI-TORSIONAL PLATE: MULTI LAYER FIBERGLASS



SIZE (CM)	150	157	164	171
WEIGHT(GR)	965	1010	1055 g	1100
RADIUS(MT)	17,50	19,50	20,08	21,10
SURFACE(CM2)	1444	1511	1569	1616
TORSION	CARBON	CARBON	CARBON	CARBON
SIDECUT(MM)	118/88/104	118/88/104	118/87/104	118/85/104



ENGLISH VIDEO

VIDEO ITALIANO



GAVIA 76 cod. 13166

4 LAYER CONTROL

Gavia76 is the ideal touring ski for those who like to climb alongside the piste as well as take on more challenging high-mountain routes. The core is made with Liwood air and 14-layer technologies guaranteeing excellent reliability and low weight. Control progressive flex, hiconnect and no shock active vibration control for safe, precise turns. The version with flex 6.0 is for lighter skiers or for those looking for softer skis especially in the back half of the ski.

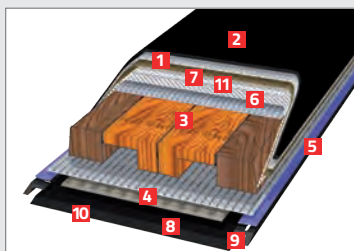

- 1 CONSTRUCTION: CAP QUADRIAXIAL
- 2 PROTECTION SHEET: PA STRONG PROTECTION
- 3 CORE: HARD WOOD-LIGHT WOOD
- 4 FIBERGLASS SUPPORT: BIAXIAL FIBERGLASS
- 5 EDGE: STEEL 52HRC
- 6 TORSION REINFORCEMENTS: CARBON-GLASS
- 7 CAP REINFORCEMENT: GLASS-BASALT
- 8 BASE: SINTERED BLACK BASE
- 9 FINISHING: EDGE RADIAL - TUNING 89°
- 10 BASE FINISHING: MICROSTRUCTURED
- 11 BINDING PLATE/ANTI-TORSIONAL PLATE: MULTI LAYER FIBERGLASS

LIWOOD AIR
DIFFERENTIATED AERO WOOD CORE

SIZE (CM)	150	157	164	171	178
WEIGHT(GR)	930	970	1035	1060	1100
RADIUS(MT)	18,40	20,50	21,70	22	24,10
SURFACE(CM2)	1308	1369	1420	1461	1519
TORSION	CARBON-GLASS	CARBON-GLASS	CARBON-GLASS	CARBON-GLASS	CARBON-GLASS
SIDECUT(MM)	108/79/94	108/79/94	108/78/94	108/76/94	108/76/94



CONTROL FLEX

DUOTAIL

HICONNECT

NOSHOCK

RADIUS CONTROL



ENGLISH VIDEO

VIDEO ITALIANO

GAVIA 85 cod. 13168

4 LAYER CONTROL

Gavia85 is a multipurpose ski suitable for all conditions, ideal for those looking for an easily manoeuvrable ski to use in all types of snow, whatever the gradient. The core is made with Liwood air and 14-layer technologies guaranteeing excellent reliability and low weight. Control progressive flex, hiconnect and no shock active vibration control for safe, precise turns. The version with flex 6.0 is for lighter skiers or for those looking for softer and more manageable skis.

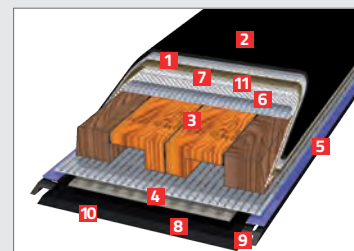

- 1 CONSTRUCTION: CAP QUADRIAXIAL
- 2 PROTECTION SHEET: PA STRONG PROTECTION
- 3 CORE: HARD WOOD-LIGHT WOOD
- 4 FIBERGLASS SUPPORT: BIAXIAL FIBERGLASS
- 5 EDGE: STEEL 52HRC
- 6 TORSION REINFORCEMENTS: CARBON-GLASS
- 7 CAP REINFORCEMENT: GLASS-BASALT
- 8 BASE: SINTERED BLACK BASE
- 9 FINISHING: EDGE RADIAL - TUNING 89°
- 10 BASE FINISHING: MICROSTRUCTURED
- 11 BINDING PLATE/ANTI-TORSIONAL PLATE: MULTI LAYER FIBERGLASS

LIWOOD AIR
DIFFERENTIATED AERO WOOD CORE

SIZE (CM)	150	157	164	171	178
WEIGHT(GR)	1015	1065	1109 g	1160	1200
RADIUS(MT)	17,50	19,50	20,08	21,10	23,10
SURFACE(CM2)	1444	1511	1569	1616	1682
TORSION	CARBON-GLASS	CARBON-GLASS	CARBON-GLASS	CARBON-GLASS	CARBON-GLASS
SIDECUT(MM)	118/88/104	118/88/104	118/87/104	118/85/104	118/85/104



CONTROL FLEX

DUOTAIL

HICONNECT

NOSHOCK

RADIUS CONTROL



ENGLISH VIDEO

VIDEO ITALIANO

STELVIO 76 cod. 13165

4 LAYER CONTROL

Stelvio76 is the ideal touring ski for those who like to climb alongside the piste as well as take on more challenging high-mountain routes. The core is made with Liwood air and 14-layer technologies guaranteeing excellent reliability and low weight. Control progressive flex, hiconnect and no shock active vibration control for safe, precise turns. The version with flex 7.0 is for heavier skiers or for those looking for greater support especially in the back half of the ski.

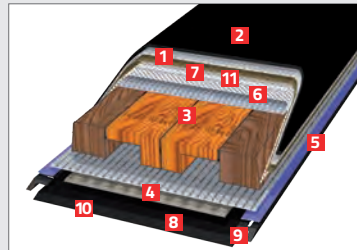

- 1 CONSTRUCTION: CAP QUADRIAXIAL
- 2 PROTECTION SHEET: PA STRONG PROTECTION
- 3 CORE: HARD WOOD-LIGHT WOOD
- 4 FIBERGLASS SUPPORT: BIAXIAL FIBERGLASS
- 5 EDGE: STEEL 52HRC
- 6 TORSION REINFORCEMENTS: CARBON-GLASS
- 7 CAP REINFORCEMENT: GLASS-BASALT
- 8 BASE: SINTERED BLACK BASE
- 9 FINISHING: EDGE RADIAL - TUNING 89°
- 10 BASE FINISHING: MICROSTRUCTURED
- 11 BINDING PLATE/ANTI-TORSIONAL PLATE: MULTI LAYER FIBERGLASS

LIWOOD AIR
DIFFERENTIATED AERO WOOD CORE

SIZE (CM)	150	157	164	171	178
WEIGHT(GR)	955	1000	1045	1090	1130
RADIUS(MT)	18,40	20,50	21,70	22	24,10
SURFACE(CM2)	1308	1369	1420	1461	1519
TORSION	CARBON-GLASS	CARBON-GLASS	CARBON-GLASS	CARBON-GLASS	CARBON-GLASS
SIDECUT(MM)	108/79/94	108/79/94	108/78/94	108/76/94	108/76/94



CONTROL FLEX

DUOTAIL

HICONNECT

NOSHOCK

RADIUS CONTROL



ENGLISH VIDEO

VIDEO ITALIANO

STELVIO 85 cod. 13167

4 LAYER CONTROL

Stelvio85 is a multipurpose ski suitable for all conditions, ideal for those looking for an easily manoeuvrable ski to use in all types of snow, whatever the gradient. The core is made with Liwood air and 14-layer technologies guaranteeing excellent reliability and low weight. Control progressive flex, hiconnect and no shock active vibration control for safe, precise turns. The version with flex 7.0 is for those looking for greater support between the centre and the tail.

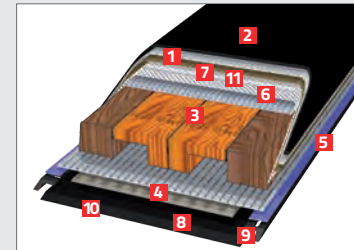

- 1 CONSTRUCTION: CAP QUADRIAXIAL
- 2 PROTECTION SHEET: PA STRONG PROTECTION
- 3 CORE: HARD WOOD-LIGHT WOOD
- 4 FIBERGLASS SUPPORT: BIAXIAL FIBERGLASS
- 5 EDGE: STEEL 52HRC
- 6 TORSION REINFORCEMENTS: CARBON-GLASS
- 7 CAP REINFORCEMENT: GLASS-BASALT
- 8 BASE: SINTERED BLACK BASE
- 9 FINISHING: EDGE RADIAL - TUNING 89°
- 10 BASE FINISHING: MICROSTRUCTURED
- 11 BINDING PLATE/ANTI-TORSIONAL PLATE: MULTI LAYER FIBERGLASS

LIWOOD AIR
DIFFERENTIATED AERO WOOD CORE

SIZE (CM)	150	157	164	171	178
WEIGHT(GR)	1050	1100	1150 g	1200	1250
RADIUS(MT)	17,50	19,50	20,08	21,10	23,10
SURFACE(CM2)	1444	1511	1569	1616	1682
TORSION	CARBON-GLASS	CARBON-GLASS	CARBON-GLASS	CARBON-GLASS	CARBON-GLASS
SIDECUT(MM)	118/88/104	118/88/104	118/87/104	118/85/104	118/85/104



CONTROL FLEX

DUOTAIL

HICONNECT

NOSHOCK

RADIUS CONTROL



ENGLISH VIDEO

VIDEO ITALIANO

14 LAYER TECH

ENJOY PURE FREE TOURING

Per ottenere uno sci leggero, facile ed affidabile è necessario amalgamare al meglio flex e rigidità torsionale. Abbiamo quindi sviluppato una tecnologia del leggero con 14 differenti strati che ci permettono di modellare la struttura dello sci senza scendere a compromessi di alcun genere. Questa tecnologia si caratterizza per aver individuato un processo produttivo capace di utilizzare un'anima leggerissima e allo stesso tempo in grado di dare una corretta rigidità torsionale ed un flex morbido e continuo alle estremità 14 differenti strati ad avvolgere un'anima ultraleggera, in maniera tale da poter raggiungere valori di flex desiderati senza in alcun modo compromettere i parametri di stabilità, flessibilità torsionale e durabilità dello sci.

For a lightweight ski that is reliable and easy to use you need to find the best way to combine flex and torsional rigidity. Hence we have developed a lightweight technology with 14 different layers to achieve Flex Performance, anti-torsional strength and maximum reliability allowing us to model the structure of the skis with no half-measures. This technology stands out for combining an extremely light core with maximum anti-torsional strength and at the same time able to provide the right amount of torsional rigidity and a soft, continuous flex up to the ends. 14 different layers wrap around an ultralight core in order to reach the desired flex values without compromising the stability, torsional flexibility and durability parameters of the skis in any way.

MISTICO / MAXIMO / SUPERMAXIMO

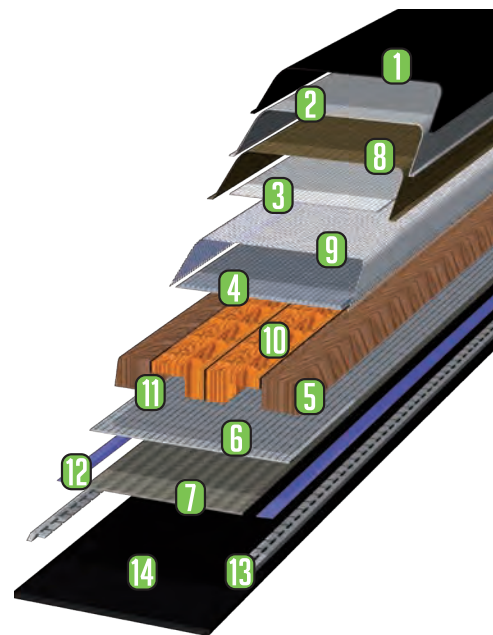

- | | | | |
|--|---|----|-------------------------------------|
| SCRATCH PROOF PA PROTECTION SHELL | 1 | 8 | CARBON/GLASS-CARBON FABRIC CAP |
| BIAXIAL CARBON FABRIC CAP | 2 | 9 | FIBERGLASS SLEEVE |
| BIAXIAL CARBON FIBER LAMINATE | 3 | 10 | LIWOOD AIR CORE |
| BINDING REINFORCEMENT ANTITORSIONAL BASE | 4 | 11 | CORE SUPPORT |
| WOODEN SIDEWALL | 5 | 12 | ELASTOMER |
| CARBON/GLASS-CARBON REINFORCEMENT | 6 | 13 | STEEL EDGE HRC 58 +/-2 |
| CARBON/GLASS-CARBON S SUPPORT | 7 | 14 | HIGH-DENSITY POLYETHYLENE UHMW BASE |



TECNOLOGIA ARAMIDE

L'Aramide è una tra le più importanti fibre sintetiche. E' usata nella tecnologia aerospaziale e militare per le incredibili caratteristiche di resistenza.

L'anima alveolare in Aramide rappresenta il miglior rapporto forza/leggerezza oggi sul mercato, SKI TRAB ha scelto il miglior materiale per mantenere alte nel tempo la stabilità, la performance e la durabilità dello sci.

ARAMID TECHNOLOGY

Aramid is among the most important synthetic fibres. It is used in aerospace and military applications due to its incredible resistance features. The Aramid honeycomb compound core represents the best strength/lightweight ratio available today on the market.

SKI TRAB has chosen the best material to obtain long-term high stability, performance and durability of the skis.

THE ARAMID COMPOUND CORE (ARAMID, LIGHT WOOD, ASH) REPRESENTS THE BEST STRENGTH/LIGHTWEIGHT RATIO AVAILABLE TODAY ON THE MARKET

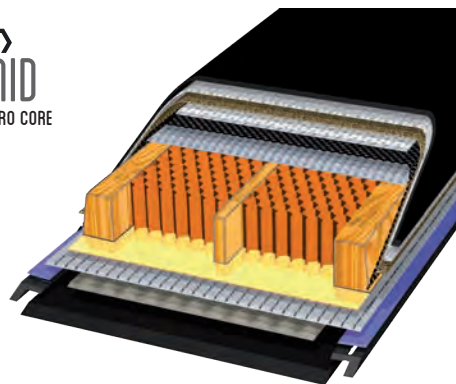

ARAMID / NOMEX

PLACE OF ORIGIN: EUROPE

USE: AEROSPACE AND AERONAUTIC

DENSITY: 70 KG M³

COMPRESSIVE STRENGTH MPA 10

CHARACTERISTICS: LIGHTWEIGHT, FLEXIBLE



LIGHT WOOD

PLACE OF ORIGIN: THE EAST

USE: WOODWORK, SKIS

DENSITY: 270/300 KG M³

COMPRESSIVE STRENGTH MPA 18

CHARACTERISTICS: LIGHTWEIGHT, EASY TO PROCESS



FRAXINUS L. / ASH TREE

PLACE OF ORIGIN: EUROPE

USE: BUILDING INDUSTRY, TOOLS, FUEL

DENSITY: 600/700 KG M³

COMPRESSIVE STRENGTH MPA 30

CHARACTERISTICS: SOLID AND HIGHLY FLEXIBLE

= ULTRALIGHT CORE COMPONENTS

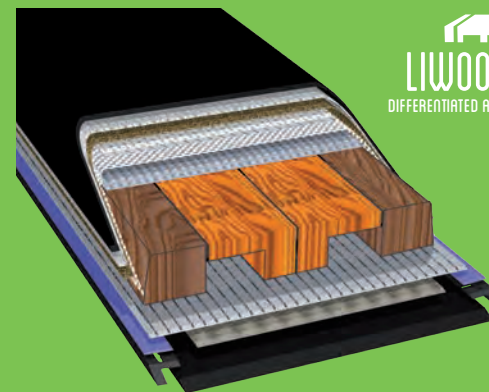

LIWOOD AIR L'EVOLUZIONE DELL'ANIMA IN LEGNO LEGGERO

Lo sci rimane leggero e performante migliorando durata e resistenza. Il legno è la materia prima più usata negli sci. Da anni si è alla ricerca del legno leggero ma allo stesso tempo lo si vorrebbe duraturo e forte. Si va contro natura. L'anima in legno leggero deve essere supportata da lavorazioni e accoppiamenti con altri legni per migliorare la forza e soprattutto aiutata da materiali in composito che avvolgendola danno rigidità torsionale e durabilità. I canali d'aria appositamente inseriti rendono lo sci più leggero senza compromettere la struttura.

LIWOOD AIR THE EVOLUTION OF THE LIGHTWEIGHT WOOD CORE

Wood is the most used raw material in ski production. For years designers have sought after a wood that is lightweight yet durable and strong, yet this goes against nature. A lightweight wood core needs to be supported by production processes and to be mixed with other types of wood to improve its strength; above all it must be wrapped by composite materials which give it torsional rigidity and durability. The air ducts make the ski lighter without compromising the structure. The light wood and hard wood compound core represents the best SOLUTION available for SKI TOURING today on the market.



LIGHT WOOD

HARD WOOD

THE LIGHT WOOD AND HARD WOOD COMPOUND CORE REPRESENTS THE BEST SOLUTION AVAILABLE FOR SKI TOURING TODAY ON THE MARKET.

LIGHT WOOD

PLACE OF ORIGIN: THE EAST

USE: WOODWORK, SKIS

DENSITY: 270/300 KG M³

COMPRESSIVE STRENGTH MPA 18

CHARACTERISTICS: LIGHTWEIGHT, EASY TO PROCESS



FRAXINUS L. / ASH TREE

PLACE OF ORIGIN: EUROPE

USE: BUILDING INDUSTRY, TOOLS, FUEL

DENSITY: 600/700 KG M³

COMPRESSIVE STRENGTH MPA 30

CHARACTERISTICS: SOLID AND HIGHLY FLEXIBLE

= LIWOOD AIR CORE

— ATTIVO PROGRESSIVE SHAPE LIWOOD AIR LEX
— STANDARD PROFILE

HIGH TORSIONAL RIGIDITY, HIGH FLEXIBILITY,
EASY TURNING
SKI: MAXIMO - SUPERMAXIMO



LIWOOD AIR FLEX

Le estremità morbide facilitano il galleggiamento e la centralità della sciata, l'ottima rigidità torsionale aiuta un perfetto controllo dello sci.

The soft tips and tails aid float and centrality while skiing, the excellent torsional rigidity aids perfect control of the ski.

— ATTIVO PROGRESSIVE FLEX
— STANDARD PROFILE

HIGH TORSIONAL RIGIDITY
SKI: MISTICO



ATTIVO FLEX

Il Flex performance della SKI TRAB si caratterizza per una zona centrale sostenuta e molto reattiva ai movimenti dello sciatore e con estremità dell'asta morbide con arco di curvatura rotondo e graduale.

Flex performance by SKI TRAB is characterised by a supported central area that is highly responsive to the movements of the skier, with soft tips and tails and a progressive rounded camber.



DUO TECH FLESSIBILITÀ DIFFERENZIATA

1. con lo sci piatto la coda mantiene una rigidità che garantisce perfetta stabilità e sostegno.
2. in curva la flessibilità della coda è maggiore migliorando la chiusura di curva e la facilità della sciata.
3. quando lo sci è piatto il taglio della coda migliora la stabilità direzionale.

DUO TECH DIFFERENT FLEXIBILITY

1. with a flat ski the tail maintains its rigidity and the ski guarantees a perfect stability and support.
2. on turning the tail flexibility is greater, improving the steering and making skiing easier.
3. with a flat ski the hollow of the ski tail increases stability and steering precision.



LOW OMEGA PROFILE

La nuova tecnologia "Low Omega Profile" crea un profilo longitudinale variabile allo scopo di modulare meglio il flex dello sci. All'esterno lo sci viene abbassato nelle zone dove serve aumentare il flex per facilitare la manovrabilità mentre in altre zone si va a rafforzare la rigidità e la tenuta torsionale che ne migliora stabilità e tenuta. Migliora le fasi di conduzione, ingresso in curva e chiusura della stessa, oltre a ridurre ulteriormente il peso di ogni singola asta.

The new technology "Low Omega Profile" creates a variable longitudinal profile in order to better modulate the flex of the ski. On the outside of the ski it is lowered in the areas where it is necessary to increase the flex in order to improve manoeuvrability, while in others it reinforces torsional stiffness and holding power for better stability and edge grip. It improves steering, entry into and closing of the turn, as well as reducing the weight of the skis.



HIBOX CONTROLLO TORSIONE

Gabbia di carbonio a trama molto sottile (3k) che avvolge internamente lo sci, conferendogli una rigidità torsionale decisamente superiore (fino al 46%). Questo tipo di lavorazione va a beneficio della sola struttura antitorsione, senza penalizzare i valori di flessione dello sci.

HIBOX TORSION CONTROL

Thin micro-mesh carbon cage (3k) which wraps around the ski providing a definitely higher torsional stiffness (up to 46%). This type of processing aims at giving benefits only to the antitorsional structure without compromising the bending values of the skis.



ACTIVE SHOCK ABSORBER

Elementi di polimero strutturale inseriti in senso longitudinale sui fianchi superiori dello sci. Hanno la funzione di assorbire le vibrazioni e dare stabilità allo sci. Inoltre svolgono un'importante protezione della struttura evitando che lo sci sia danneggiato da colpi e tagli che potrebbero facilmente intaccare gli spigoli e aprire la struttura interna.

Structural polymer components are integrated lengthwise on the top sides of the skis. Their function is to absorb the vibrations providing an enhanced stability to the skis. They also play an important role in protecting the structure by preventing the skis to be ruined by blows or cuts which might easily damaged the edges and open the internal structure.



HICONNECT COLLEGAMENTO TRA LE LAMINE ESTREMAMENTE RESISTENTE

Per mantenere alta nel tempo la planarità abbiamo realizzato un ponte che collega le due lamine internamente, in maniera tale da renderle un tutt'uno difficile da disassare. Questa speciale costruzione permette di tenere le lamine in sede anche dopo impatti importanti con rocce o altro.

HICONNECT STRONG EDGE TO EDGE CONNECTION

In order to maintain the flatness of the ski over time we have designed a bridge that connects the two edges internally, in such a way that it is almost impossible to misalign. This special construction means that the edges stay where they should be, even after multiple impacts with hard surfaces like rocks.



NO SHOCK, CONTROLLO ATTIVO DELLE VIBRAZIONI

Una striscia di elastomero speciale viene posta longitudinalmente tra le lamine e la struttura interna dello sci. In punta ed in coda l'elastomero copre tutta la superficie dello sci. L'inserimento di questo elemento crea una sorta di ammortizzazione che rende lo sci più stabile e più lineare nella risposta agli stimoli impressi.

NO SHOCK, ACTIVE VIBRATION CONTROL

A band of a special elastomer is placed lengthways between the edges and the internal structure of the ski. At the tip and the tail, the elastomer covers the entire surface of the ski. Its addition creates a cushioning effect that makes the ski more stable and more linear in response to external factors.

MISTICO cod. 13180



An extremely lightweight ski considering its considerable width. Ideal for those who don't want to compromise, looking for maximum performance and comfort; perfect on powder as well as crust snow. The Aramid core and 14-layer construction guarantee reliability and lightness. Active progressive flex, hiconnect bridge between edges and a Hibox torsion box for excellent reliability and durability.

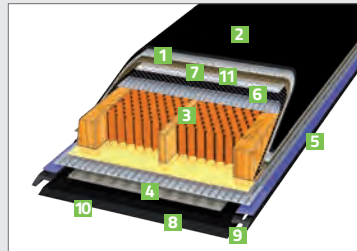

- 1 CONSTRUCTION: CAP QUADRIAXIAL
- 2 PROTECTION SHEET: PA LIGHT PROTECTION
- 3 CORE: ARAMID-ASH WOOD-LIGHT WOOD
- 4 FIBERGLASS SUPPORT: BIAxIAL FIBERGLASS
- 5 EDGE: STEEL 52HRC
- 6 TORSION REINFORCEMENTS: CARBON HM
- 7 CAP REINFORCEMENT: CARBON-BASALT
- 8 BASE: SINTERED BLACK BASE
- 9 FINISHING: EDGE RADIAL - TUNING 89°
- 10 BASE FINISHING: RACE MICROSTRUCTURED
- 11 BINDING PLATE/ANTI-TORSIONAL PLATE: MULTI LAYER FIBERGLASS



SIZE (CM)	164	171	178	185
WEIGHT(GR)	1075	1120	1150	1185
RADIUS(MT)	18,10	18,5	20,50	20,90
SURFACE(CM2)	1634	1687	1756	1805
TORSION	CARBON	CARBON	CARBON	CARBON
SIDECUT(MM)	121/92/110	121/90/110	121/90/110	121/88/110



SUPERMAXIMO cod. 13172



Supermaximo is a ski for pure fun off-piste, designed for deep, fresh snow. The core is built with Liwood air and 14-layer technologies for reliability and performance. Active progressive flex, hiconnect, no shock active vibration control and Low Omega Profile, together with the generous width of the ski ensure ease of use and excellent performance.

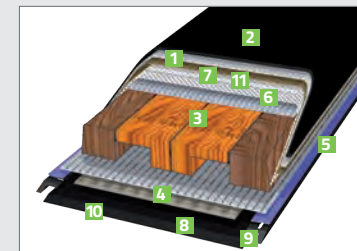

- 1 CONSTRUCTION: CAP QUADRIAXIAL
- 2 PROTECTION SHEET: PA STRONG PROTECTION
- 3 CORE: HARD WOOD-LIGHT WOOD
- 4 FIBERGLASS SUPPORT: BIAxIAL FIBERGLASS
- 5 EDGE: STEEL 52HRC
- 6 TORSION REINFORCEMENTS: CARBON-GLASS
- 7 CAP REINFORCEMENT: GLASS-BASALT
- 8 BASE: SINTERED BLACK BASE
- 9 FINISHING: EDGE RADIAL - TUNING 89°
- 10 BASE FINISHING: MICROSTRUCTURED
- 11 BINDING PLATE/ANTI-TORSIONAL PLATE: MULTI LAYER FIBERGLASS



SIZE (CM)	171	178	185
WEIGHT(GR)	1290 g	1340	1390
RADIUS(MT)	18,5	20,5	20,09
SURFACE(CM2)	1783	1858	1909
TORSION	CARBON-GLASS	CARBON-GLASS	CARBON-GLASS
SIDECUT(MM)	127/96/116	127/96/116	127/94/116



MAXIMO 6.0 cod. 13171



Maximo is a ski designed for performance and safety on all types of snow, perfect for those looking for fun in descent. The core is made with Liwood air and 14-layer technologies guaranteeing performance and reliability. Active progressive flex, hiconnect and no shock active vibration control and Low Omega Profile offer fun and easy skiing. The version with flex 6.0 is for lighter skiers or for those looking for softer and more manageable skis.

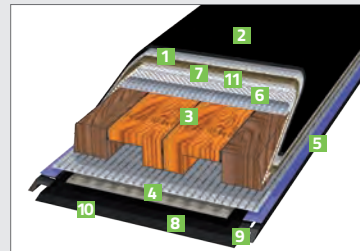

- 1 CONSTRUCTION: CAP QUADRIAXIAL
- 2 PROTECTION SHEET: PA STRONG PROTECTION
- 3 CORE: HARD WOOD-LIGHT WOOD
- 4 FIBERGLASS SUPPORT: BIAXIAL FIBERGLASS
- 5 EDGE: STEEL 52HRC
- 6 TORSION REINFORCEMENTS: CARBON-GLASS
- 7 CAP REINFORCEMENT: GLASS-BASALT
- 8 BASE: SINTERED BLACK BASE
- 9 FINISHING: EDGE RADIAL - TUNING 89°
- 10 BASE FINISHING: MICROSTRUCTURED
- 11 BINDING PLATE/ANTI-TORSIONAL PLATE: MULTI LAYER FIBERGLASS



SIZE (CM)	157	164	171	178	185
WEIGHT(GR)	1110	1160	1200	1250	1315
RADIUS(MT)	17,8	18,10	18,5	20,50	20,90
SURFACE(CM2)	1579	1634	1687	1756	1805
TORSION	CARBON-GLASS	CARBON-GLASS	CARBON-GLASS	CARBON-GLASS	CARBON-GLASS
SIDECUT(MM)	121/94/110	121/92/110	121/90/110	121/90/110	121/88/110

MAXIMO 7.0 cod. 13170



Maximo is a ski designed for performance and safety on all types of snow, perfect for those looking for fun in descent. The core is made with Liwood air and 14-layer technologies guaranteeing performance and reliability. Active progressive flex, hiconnect and no shock active vibration control and Low Omega Profile offer fun and easy skiing. The version with flex 7.0 is for more powerful skiers or who want greater support for fast skiing.

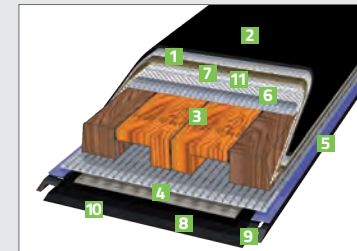

- 1 CONSTRUCTION: CAP QUADRIAXIAL
- 2 PROTECTION SHEET: PA STRONG PROTECTION
- 3 CORE: HARD WOOD-LIGHT WOOD
- 4 FIBERGLASS SUPPORT: BIAXIAL FIBERGLASS
- 5 EDGE: STEEL 52HRC
- 6 TORSION REINFORCEMENTS: CARBON-GLASS
- 7 CAP REINFORCEMENT: GLASS-BASALT
- 8 BASE: SINTERED BLACK BASE
- 9 FINISHING: EDGE RADIAL - TUNING 89°
- 10 BASE FINISHING: MICROSTRUCTURED
- 11 BINDING PLATE/ANTI-TORSIONAL PLATE: MULTI LAYER FIBERGLASS



SIZE (CM)	157	164	171	178	185
WEIGHT(GR)	1130	1190	1220	1280	1340
RADIUS(MT)	17,8	18,10	18,5	20,50	20,90
SURFACE(CM2)	1579	1634	1687	1756	1805
TORSION	CARBON-GLASS	CARBON-GLASS	CARBON-GLASS	CARBON-GLASS	CARBON-GLASS
SIDECUT(MM)	121/94/110	121/92/110	121/90/110	121/90/110	121/88/110



14 LAYER CONTROL

MAXIMUM DURABILITY FOR RENTAL

La nuova tecnologia 14-Layer Control ha questo scopo, rendere lo sci un attrezzo che ti aiuta a vincere le situazioni difficili quali le nevi crostose e irregolari e allo stesso tempo darti una sensazione di controllo, di sicurezza e di massima soddisfazione durante la sciata.

Nasce dalla classica costruzione 14 strati SKI TRAB che è il massimo sinonimo di affidabilità e performance nella costruzione degli sci da scialpinismo, quindi sono stati sviluppati nuovi shape con punti di contatto sulla neve rivoluzionati per facilitare l'ingresso in curva e la conducibilità dello sci.

I nuovi raggi e il baricentro spostato in avanti con un nuovo tipo di flex danno allo sci un assetto innovativo che ne favorisce il controllo e la performance in discesa.

Uno sci per tutti gli stili che si adatta a tutte le nevi e pendii in maniera ottimale.

The new 14-layer control technology is designed with this in mind: to make the ski a piece of equipment that helps you to overcome difficult situations such as irregular and ice-encrusted snow, while at the same time giving you a sense of control, safety and maximum satisfaction while skiing.

It follows on from the classic SKI TRAB 14-layer construction that is synonymous with reliability and performance in the production of touring skis. New shapes have been developed with revolutionary contact points on the snow that facilitate entry into the turn and the carving motion of the ski.

The new radius and the movement of the barycentre towards the front together with a new type of flex give the ski an innovative structure which enhances control and performance in descent. One ski for all styles that adapts perfectly to all types of snow and gradient.

STELVIO RENTAL

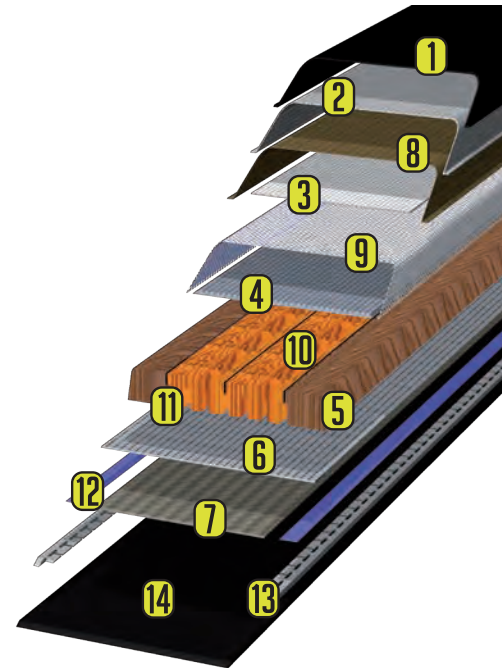

- | | | | |
|--|---|----|-------------------------------------|
| RENTAL SCRATCH PROOF PA PROTECTION SHELL | 1 | 8 | GLASS FABRIC CAP |
| BIAXIAL CARBON FABRIC CAP | 2 | 9 | FIBERGLASS SLEEVE |
| BIAXIAL CARBON FIBER LAMINATE | 3 | 10 | LIWOOD AIR CORE |
| BINDING REINFORCEMENT ANTITORSIONAL BASE | 4 | 11 | CORE SUPPORT |
| WOODEN SIDEWALL | 5 | 12 | ELASTOMER |
| BASALT FIBER REINFORCEMENT | 6 | 13 | RENTAL STEEL EDGE HRC 58 +/-2 |
| FIBREGLASS SUPPORT | 7 | 14 | HIGH-DENSITY POLYETHYLENE UHMW BASE |

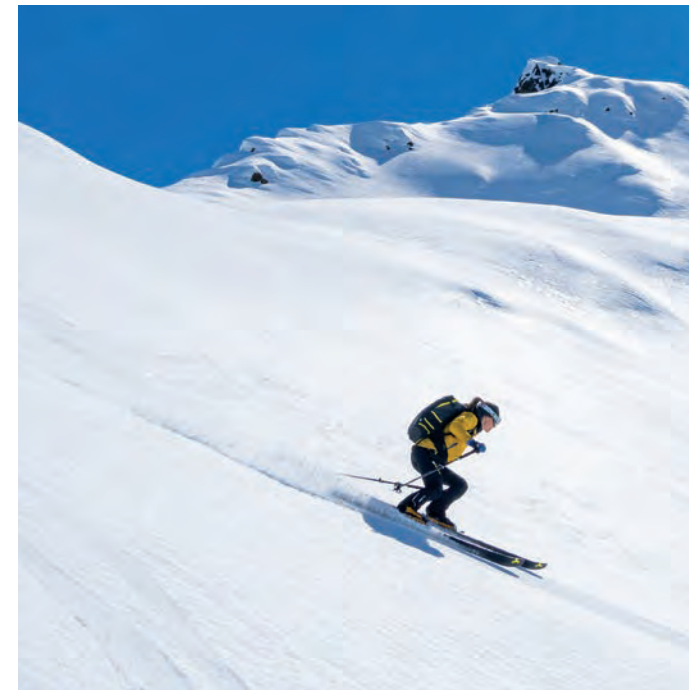

LIWOOD CORE



Il legno è la materia prima più usata negli sci. Da anni si è alla ricerca del legno leggero ma allo stesso tempo lo si vorrebbe duraturo e forte. Si va contro natura. L'anima in legno leggero deve essere supportata da lavorazioni e accoppiamenti con altri legni per migliorare la forza e soprattutto aiutata da materiali in composito che avvolgendola danno rigidità torsionale e durabilità.

Wood is the most used raw material in ski production. For years designers have sought after a wood that is lightweight yet durable and strong, yet this goes against nature. A lightweight wood core needs to be supported by production processes and to be mixed with other types of wood to improve its strength; above all it must be wrapped by composite materials which give it torsional rigidity and durability.

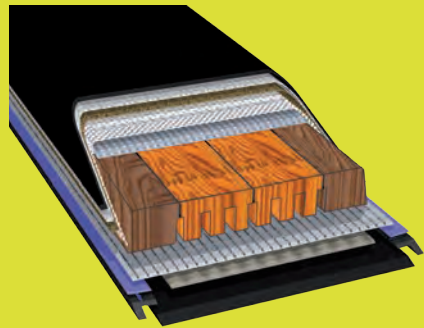

THE LIGHT WOOD AND HARD WOOD COMPOUND CORE REPRESENTS THE BEST SOLUTION AVAILABLE FOR SKI TOURING TODAY ON THE MARKET.

LIGHT WOOD

PLACE OF ORIGIN: THE EAST

USE: WOODWORK, SKIS

DENSITY: 270/300 KG M³

COMPRESSIVE STRENGTH MPA 18

CHARACTERISTICS: LIGHTWEIGHT, EASY TO PROCESS



FRAXINUS L. / ASH TREE

PLACE OF ORIGIN: EUROPE

USE: BUILDING INDUSTRY, TOOLS, FUEL

DENSITY: 600/700 KG M³

COMPRESSIVE STRENGTH MPA 30

CHARACTERISTICS: SOLID AND HIGHLY FLEXIBLE

LIWOOD FLEX
EASY TURNING FLEX

LIWOOD FLEX
Le estremità morbide facilitano il galleggiamento e la centralità della sciata, l'ottima rigidità torsionale aiuta un perfetto controllo dello sci.

The soft tips and tails aid float and centrality while skiing, the excellent torsional rigidity aids perfect control of the ski.

HISTRENGTH RENTAL DURABILITY

Una struttura portante con tecnologia 14 strati e anima in legno leggero con fianchi più robusti ed inoltre superfici più resistenti e lamine più spessorate sono la nostra soluzione per migliorare la durabilità degli sci Rental.

A supporting structure with 14 layer technology and light wood core, as well as stronger sides, scratch-resistant surfaces and thicker edges – our solution to improve the durability of rental skis.

DUOTAIL DIFFERENT TAIL FLEXIBILITY

DUO TAIL FLESSIBILITÀ DIFFERENZIATA

- con lo sci piatto la coda mantiene una rigidità che garantisce perfetta stabilità e sostegno.
- in curva la flessibilità della coda è maggiore migliorando la chiusura di curva e la facilità della sciata.
- quando lo sci è piatto il taglio della coda migliora la stabilità direzionale.

DUO TAIL DIFFERENT FLEXIBILITY

- with a flat ski the tail maintains its rigidity and the ski guarantees a perfect stability and support.
- on turning the tail flexibility is greater, improving the steering and making skiing easier.
- with a flat ski the hollow of the ski tail increases stability and steering precision.

HICONNECT COLLEGAMENTO TRA LE LAMINE ESTREMAMENTE RESISTENTE

Per mantenere alta nel tempo la planarità abbiamo realizzato un ponte che collega le due lamine internamente, in maniera tale da renderle un tutt'uno difficile da disassare. Questa speciale costruzione permette di tenere le lamine in sede anche dopo impatti importanti con rocce o altro.

HICONNECT HIGH MODULE CARBON TORSION CONTROL

HICONNECT STRONG EDGE TO EDGE CONNECTION

In order to maintain the flatness of the ski over time we have designed a bridge that connects the two edges internally, in such a way that it is almost impossible to misalign.

This special construction means that the edges stay where they should be, even after multiple impacts with hard surfaces like rocks.

RADIUS CONTROL CONTROL RADIUS TECHNOLOGY

RADIUS CONTROL

I raggi hanno la funzione abbinata al flex di condurre lo sciatore in fase di curva. Un'innovativa correlazione con flex e raggi facilita l'entrata in curva e migliora il controllo e la conduzione dello sci in uscita di curva.

The radius, along with the flex, help to drive the skier into a turn. An innovative correlation between flex and radius facilitates entry into the turn and improves control and exit from the turn.

NOSHOCK ACTIVE VIBRATION CONTROL

NO SHOCK, CONTROLLO ATTIVO DELLE VIBRAZIONI

Una striscia di elastomero speciale viene posta longitudinalmente tra le lamine e la struttura interna dello sci. In punta ed in coda l'elastomero copre tutta la superficie dello sci. L'inserimento di questo elemento crea una sorta di ammortizzazione che rende lo sci più stabile e più lineare nella risposta agli stimoli impressi.

NO SHOCK, ACTIVE VIBRATION CONTROL

A band of a special elastomer is placed lengthways between the edges and the internal structure of the ski. At the tip and the tail, the elastomer covers the entire surface of the ski. Its addition creates a cushioning effect that makes the ski more stable and more linear in response to external factors.

STELVIO 76 RENTAL cod. 13173



Stelvio 76 is the ideal touring ski for those who like to climb alongside the piste as well as take on more challenging high-mountain routes. The core is made with Liwood air and 14-layer technologies guaranteeing excellent reliability and low weight. Control progressive flex, hiconnect and no shock active vibration control for safe, precise turns. The rental version includes an anti-scratch coating, harder base and thicker edges.

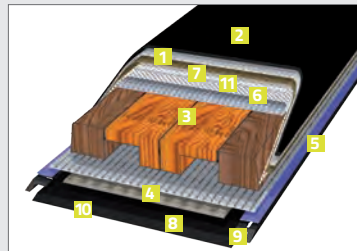

- 1 CONSTRUCTION: CAP QUADRIAXIAL
- 2 PROTECTION SHEET: PA RENTAL PROTECTION
- 3 CORE: HARD WOOD-LIGHT WOOD
- 4 FIBERGLASS SUPPORT: BIAXIAL FIBERGLASS
- 5 EDGE: STEEL 52HRC RENTAL
- 6 TORSION REINFORCEMENTS: CARBON-GLASS
- 7 CAP REINFORCEMENT: GLASS-BASALT
- 8 BASE: SINTERED BLACK BASE
- 9 FINISHING: EDGE RADIAL - TUNING 89°
- 10 BASE FINISHING: MICROSTRUCTURED
- 11 BINDING PLATE/ANTI-TORSIONAL PLATE: MULTI LAYER FIBERGLASS



SIZE (CM)	150	157	164	171	178
WEIGHT(GR)	970	1015	1060	1105	1145
RADIUS(MT)	18,40	20,50	21,70	22	24,10
SURFACE(CM2)	1308	1369	1420	1461	1519
TORSION	CARBON-GLASS	CARBON-GLASS	CARBON-GLASS	CARBON-GLASS	CARBON-GLASS
SIDECUT(MM)	108/79/94	108/79/94	108/78/94	108/76/94	108/76/94

STELVIO 85 RENTAL cod. 13174



Stelvio 85 Rental is a multipurpose ski suitable for all conditions, ideal for those looking for an easily manoeuvrable ski to use in all types of snow, whatever the gradient. The core is made with Liwood air and 14-layer technologies guaranteeing excellent reliability and low weight. Control progressive flex, hiconnect and no shock active vibration control for safe, precise turns. The rental version includes an anti-scratch coating, harder base and thicker edges.

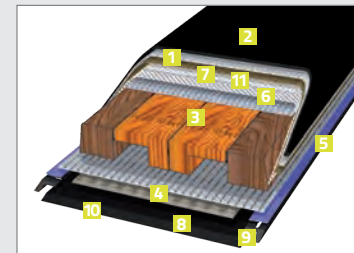

- 1 CONSTRUCTION: CAP QUADRIAXIAL
- 2 PROTECTION SHEET: PA RENTAL PROTECTION
- 3 CORE: HARD WOOD-LIGHT WOOD
- 4 FIBERGLASS SUPPORT: BIAXIAL FIBERGLASS
- 5 EDGE: STEEL 52HRC RENTAL
- 6 TORSION REINFORCEMENTS: CARBON-GLASS
- 7 CAP REINFORCEMENT: GLASS-BASALT
- 8 BASE: SINTERED BLACK BASE
- 9 FINISHING: EDGE RADIAL - TUNING 89°
- 10 BASE FINISHING: MICROSTRUCTURED
- 11 BINDING PLATE/ANTI-TORSIONAL PLATE: MULTI LAYER FIBERGLASS



SIZE (CM)	150	157	164	171	178
WEIGHT(GR)	1080	1130	1180 g	1230	1280
RADIUS(MT)	17,50	19,50	20,08	21,10	23,10
SURFACE(CM2)	1444	1511	1569	1616	1682
TORSION	CARBON-GLASS	CARBON-GLASS	CARBON-GLASS	CARBON-GLASS	CARBON-GLASS
SIDECUT(MM)	118/88/104	118/88/104	118/87/104	118/85/104	118/85/104



ENGLISH VIDEO

VIDEO ITALIANO



ENGLISH VIDEO

VIDEO ITALIANO

BINDING



ENGLISH VIDEO

VIDEO ITALIANO

TITAN GARA PURE PERFORMANCE

L'attacco usato dai grandi campioni. Leggero ,affidabile e facile da utilizzare.

L'elasticità, la forza progressiva di pinzatura e l'impossibilità che neve o ghiaccio impediscano la calzata dello scarponne sono i punti che rendono il puntale Titan unico ed inimitabile nel mondo delle competizioni.

L'elasticità dell'elemento in titanio del puntale permette di assorbire i picchi di forza a cui è sottoposto l'attacco in un uso gara permettendo in questo modo di ridurre o evitare danni seri all'attrezzatura e all'atleta stesso.

The binding used by champions: lightweight, reliable and easy to use.

The elasticity, the progressive clamping force and the impossibility of snow and ice stopping the binding from closing properly are what make the Titan binding unique and inimitable in the race circuit.

The elasticity of the titanium element in the toe piece lets it absorb the shocks the binding receives in a race, reducing or avoiding serious damage to the equipment and the skier.

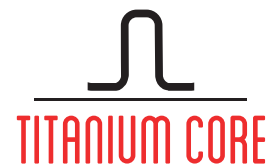

TITANIUM CORE

TITANIUM CORE

Un solo e semplice elemento in titanio particolarmente studiato nella sua forma e geometria collega le due ganasce del puntale. Questo meccanismo così semplice fornisce una importante garanzia di funzionalità e di affidabilità. L'apertura delle ganasce del puntale avviene con una facile pressione della leva anteriore, è possibile agire su quest'ultima con la mano o con il bastoncino. Nel momento in cui le spine delle ganasce sono allineate con i fori dello scarpone basta rilasciare la leva e le ganasce si chiudono bloccando la punta dello scarpone. Con la mano si ruota la stessa leva verso l'alto per bloccare l'apertura delle ganasce. Il particolare elemento elastico in titanio permette al puntale di adeguarsi perfettamente a tutti i tipi di scarponi, garantisce un ottimo bloccaggio dello scarpone e con l'aiuto di spine particolarmente rifinite e lavorate riesce a ripulire il foro scarpone durante l'uso.

One simple component in titanium specially designed in its shape and structure links the two jaws in the toe unit. This extremely simple mechanism offers a significant guarantee of functionality and reliability. The toe unit jaws open with a light pressure on the front lever, which can be pressed either by hand or with a ski pole. Position the boot so that the jaw pins are level with the holes on the side of the boot, then release the lever so the jaws close locking the toe of the boot into place. Rotate the lever upwards to block the opening of the jaws. This special elastic component in titanium permits the toe unit to adapt perfectly to all types of boots, guarantees that the boot remains fixed in place and with the help of some particularly well finished and crafted pins it can clean out the boot inserts during use.



ELASTIC TITANIUM CORE

ELASTIC TITANIUM CORE

L'elemento elastico in titanio (molla a filo sagomata) assicura al sistema un'importante elasticità che permette all'attacco di assorbire gli impatti dovuti a cadute. In questo modo gli elementi dell'attacco, l'ancoraggio allo sci o lo stesso sciatore subiscono un colpo/stress assorbito dall'elasticità del sistema e non uno strappo violento in caso di urto o caduta.

The titanium elastic element (shaped wire spring) ensures remarkable elasticity that allows the binding to absorb the impact of falls. In this way the binding parts, the ski and the skier themselves experience a hit that has been absorbed by the elasticity of the system and not a violent blow in case of a bump or fall.



ROTORIVETED PINS

ROTO-RIVETED PINS

Inseri scarpone del puntale in acciaio temperato con incavo autopulente. Roto rivettatura per ancoraggio stabile e duraturo.

Boot pins of the front unit made of hardened steel with self-cleaning hollow. Roto-riveting for a steady and durable anchorage.



ZERO AND CLICK

ZERO AND CLICK

La talloniera ha un innovativo sistema a scatto che permette un facile passaggio dalla posizione di salita a quella di discesa, inoltre la talloniera può essere ruotata di 90° permettendo in fase di salita l'appoggio dello scarpone sul piano dello sci migliorando la lunghezza del passo (angolo 0°)

The heel unit has an innovative snap system that allows an easy transition from an uphill (5.7° angle) to a downhill position and can be rotated 90° allowing the boot to rest on the ski when moving uphill improving the length of stride (0° angle).

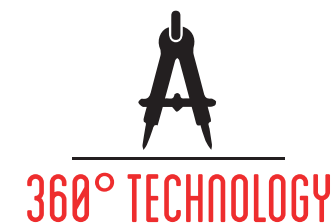

360° TECHNOLOGY

360° TECHNOLOGY

Un attacco semplice ma che utilizza la sintesi di diverse tecnologie di lavorazione del leggero: forgiatura dell'alluminio, fresatura acciaio / alluminio, stampaggio polimeri speciali, lavorazioni e trattamenti del titanio.

A simple binding which is nevertheless the synthesis of different lightweight processing technologies: aluminium forging, steel/aluminium milling, special polymer molding, titanium processing and treatments.

TITAN GARA



LEVA ANTERIORE
BLOCCO/SBLOCCO ATTACCO
IN TECNOPOLIMERO
TECHNOPOLYMER
LOCK/UNLOCK FRONT LEVER

PIN IN ACCIAIO TEMPRATO ROTORIBATTUTO
ROTO-RIVETED HARDENED STEEL PIN

ALZATACCO CON 2 POSIZIONI
2 POSITION CLIMBING AID



MOLLA A U IN TITANIO
TITANIUM SPRING

ALETTE FORGIATE IN ALLUMINIO
FORGED ALUMINIUM JAWS

CAMBIO MODALITA' SALITA-DISCESA FACILE E VELOCE
EASY AND INTUITIVE TO SWITCH FROM UPHILL TOURING TO DOWNHILL
SKIING MODE

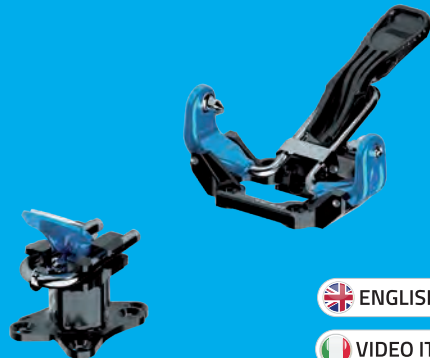

ENGLISH VIDEO

VIDEO ITALIANO

TITANIUM CORE

ELASTIC TITANIUM CORE

360° TECHNOLOGY

ZERO AND CLICK

ROTORIVETED PINS

TITAN GARA WORLD CUP

COD. 40236.BLU

The GARA TITAN binding has an innovative toe unit of one simple component in titanium. Elasticity, strength and independence characterise this ultra-lightweight binding. The heel unit has an innovative snap system that allows an easy transition from an uphill to a downhill position and can be rotated 90°. Lighter version with U spring in Titanium. Crampon attachment not included.



108 gr

↓ ↑	Ski brake	NO SKI BRAKE
↓ ↓	Weight	108 gr
↘	Downhill angle	0.7°
↗	Uphill angle	0° - 6°
↔	Heel setting	No setting
⊗	Material	Ergal - Titanium - Steel - Technopolymer Titanium
↑ ↓	Release	TITAN SPRING

TITAN GARA COD. 40237.BLU

The GARA TITAN binding has an innovative toe unit of one simple component in titanium. Elasticity, strength and independence characterise this ultra-lightweight binding. The heel unit has an innovative snap system that allows an easy transition from an uphill to a downhill position and can be rotated 90°. Crampon attachment included.



119 gr

↓ ↑	Ski brake	NO SKI BRAKE
↓ ↓	Weight	5.0 - 120 gr / 4.5 - 4.0 - 119 gr
↘	Downhill angle	0.7°
↗	Uphill angle	0° - 6°
↔	Heel setting	No setting
⊗	Material	Ergal - Titanium - Steel - Technopolymer Titanium
↑ ↓	Release	5.0 - 4.5 - 4.0

BINDING



 ENGLISH VIDEO

 VIDEO ITALIANO

TITAN VARIO.2

POWER OF THE TITAN

La leggerezza, il confort e la qualità di sgancio sono gli obiettivi del nuovo Titan Vario.

Un attacco leggero in grado di offrire una innovativa e facile calzata dell'attacco, uno ski stopper funzionale che contemporaneamente al cambiamento di assetto discesa/salita si abilita e disabilita ed una qualità di sgancio unica: puntale elastico con ganasce indipendenti a forza di sgancio crescente, posteriore con elasticità laterale fino a 43° gradi, ski stopper con elemento antifrizione laterale, posteriore montato su carrello scorrevole con elasticità fino a 8 mm.

Lightness, comfort and quality of release: the advantages of the new Titan Vario.

In a lightweight binding we offer an innovative and easy to use binding, a functional ski stopper that activates/deactivates simultaneously when changing between ascent and descent modes and a unique quality of release: elastic toe piece with independent jaws that increase release resistance, heel piece with a lateral elasticity of up to 43°, ski stopper with lateral anti-friction element, heel piece mounted on a slider track with an elasticity of up to 8mm.



FRONT UNIT

10° OPENING ONLY ON ONE SIDE

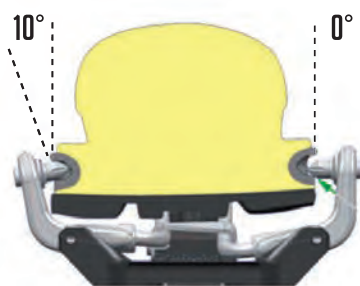

PIN WORKS

10° OPENING ON TWO SIDES

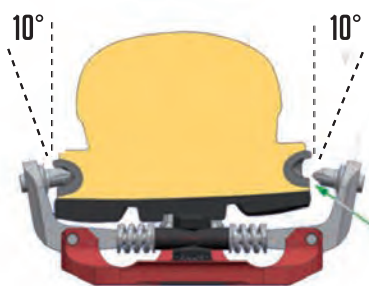

PIN DOESN'T WORK

Comparison between the Titan toe jaw independence and the toe unit with traditional system.

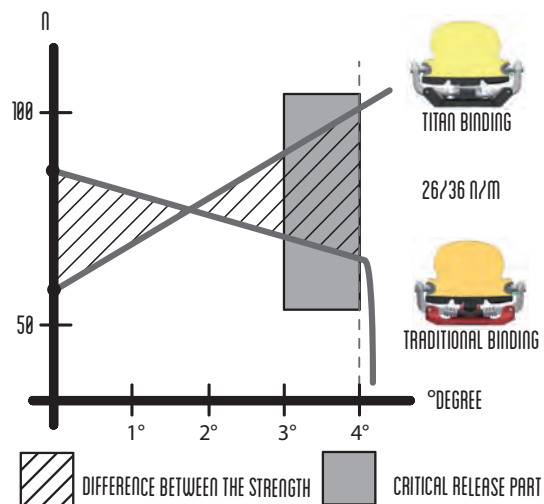

Comparison between the release STRENGTHS of the Titan toe unit and a toe unit with traditional system

FRONT UNIT

Forza e indipendenza delle ganasce Titan riducono il rischio di perdere lo sci in maniera accidentale.

Il sistema titan permette alle ganasce di lavorare indipendentemente una dall'altra.

Necessità del puntale è quella di contenere il movimento laterale dello scarpone fino ai 4°.

The strength and independence of the Titan jaws reduce the risk of losing the skis accidentally.

The Titan system allows the jaws to work independently of each other.

The toe unit should hold the lateral movement of the ski boot till 4°.

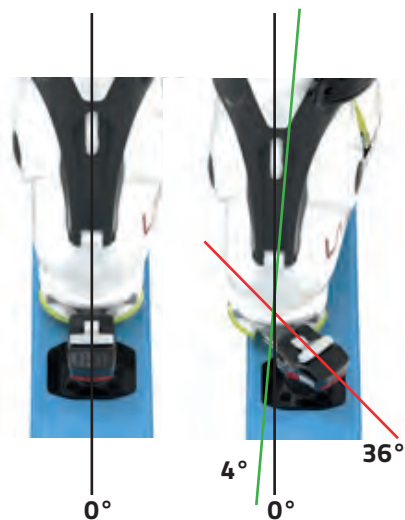

BACK UNIT

ELASTICITY

E' necessario un sistema che assorba i picchi di forza (vibrazioni e impatti) in fase di sciata. Per la talloniera sono necessari un angolo e una forza elastica (minimo 36°) in grado di riportare lo scarpone in posizione centrale.

We need a system capable of absorbing shocks (vibrations and impacts) when skiing.

As regards the heel unit we need an angle and an elastic strength (min. 36°) able to reposition the ski boot in a central position.

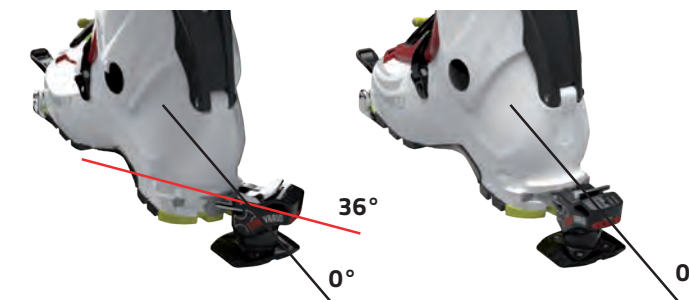

FRONTAL AND LATERAL RELEASE

Tutti gli attacchi devono avere sganci frontali e laterali in caso di caduta.

All ski bindings should have front and lateral release systems in case of a fall.



SLIDER TRACK

In caso di flessione dello sci, una talloniera fissa non permette lo sgancio laterale in posizione di sci flesso. E' necessario che l'attacco possa muoversi su un carrello per far sì che lo sgancio laterale non venga compromesso.

In case of ski flexion, a fixed heel unit does not allow a lateral release in a position of flexed ski. It is necessary that the ski binding can move on a track so that the lateral release is not put in jeopardy.



SKISTOPPER NO FRICTION

La forza di sgancio dello scarpone non deve essere influenzata dallo skistopper. Il sistema No-Friction permette di togliere attriti e frizioni in caso di sgancio laterale.

The release strength of the ski boot should not be influenced by the ski brake. The No-Friction System allows to remove any friction or rubbing in case of a lateral release.

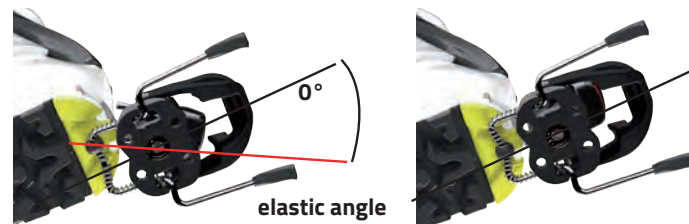



TITANIUM CORE

TITANIUM CORE

Un solo e semplice elemento in titanio particolarmente studiato nella sua forma e geometria collega le due ganasce del puntale. Questo meccanismo così semplice fornisce una importante garanzia di funzionalità e di affidabilità. L'apertura delle ganasce del puntale avviene con una facile pressione della leva anteriore, è possibile agire su quest'ultima con la mano o con il bastoncino. Nel momento in cui le spine delle ganasce sono allineate con i fori dello scarpone basta rilasciare la leva e le ganasce si chiudono bloccando la punta dello scarpone. Con la mano si ruota la stessa leva verso l'alto per bloccare l'apertura delle ganasce. Il particolare elemento elastico di titanio permette al puntale di adeguarsi perfettamente a tutti i tipi di scarponi, garantisce un ottimo bloccaggio dello scarpone e con l'aiuto di spine particolarmente rifinite e lavorate riesce a ripulire il foro scarpone durante l'uso.

One simple component in titanium specially designed in its shape and structure links the two jaws in the toe unit. This extremely simple mechanism offers a significant guarantee of functionality and reliability. The toe unit jaws open with a light pressure on the front lever, which can be pressed either by hand or with a ski pole. Position the boot so that the jaw pins are level with the holes on the side of the boot, then release the lever so the jaws close locking the toe of the boot into place. Rotate the lever upwards to block the opening of the jaws. This special elastic component in titanium permits the toe unit to adapt perfectly to all types of boots, guarantees that the boot remains fixed in place and with the help of some particularly well finished and crafted pins it can clean out the boot inserts during use.



ELASTIC TITANIUM CORE

ELASTIC TITANIUM CORE

L'elemento elastico in titanio (molla a filo sagomata) assicura al sistema un'importante elasticità che permette all'attacco di assorbire gli impatti dovuti a cadute. In questo modo gli elementi dell'attacco, l'ancoraggio allo sci o lo stesso sciatore subiscono un colpo/stress assorbito dall'elasticità del sistema e non uno strappo violento in caso di urto o caduta.

The titanium elastic element (shaped wire spring) ensures remarkable elasticity that allows the binding to absorb the impact of falls. In this way the binding parts, the ski and the skier themselves experience a hit that has been absorbed by the elasticity of the system and not a violent blow in case of a bump or fall.



INDEPENDENT JAWS

INDEPENDENT TITANIUM JAWS

Il sistema Titan permette alle ganasce di avere una certa indipendenza tra di loro, al contrario di quelli a pin tradizionale in cui entrambe le ganasce si muovono simmetricamente, che riduce la possibilità di svicolo accidentale. La presa dello scarpone risulta in questo modo molto più performante e sicura.

The Titan system allows the jaws to work independently of each other, unlike a traditional pin system where the jaws move symmetrically, reducing the chance of accidental release. The boot hold is therefore more effective and safe.



STRONG TITANIUM CORE

STRONG TITANIUM JAWS

La molla a filo in titanio sagomata offre una resistenza incrementale in fase sgancio, al contrario del sistema tradizionale che perde forza mentre si apre, questo fa sì che la presa e la tenuta dello scarpone è molto più elevata rispetto ai classici attacchi e permette di scegliere anche durante la camminata di avere la possibilità di sgancio attacco o blocco.

The shaped titanium wire spring ensures increased strength when releasing the binding, unlike the traditional system that loses strength when opening, this means that the grip of the boot is much better compared to classic bindings and lets the skier decide even when walking to release or block the binding.



FUNCTIONAL RELEASE

FUNCTIONAL RELEASE

Non ci siamo fermati alla funzionalità e all'affidabilità ma abbiamo introdotto il concetto di sgancio funzionale: un'innovativa soluzione che permette allo sgancio laterale di assorbire i picchi di forza che si creano sciando in velocità e su nevi dure, vibrazioni importanti che potrebbero far sganciare l'attacco. Solo con questo accorgimento possiamo consigliare di sciare con l'attacco predisposto in posizione di discesa rendendo quindi possibile il funzionamento degli sganci frontali e laterali in caso di caduta. Gli sganci laterali e frontali hanno una taratura fissa non regolabile corrispondente ad un livello di sciatore avanzato con caratteristiche fisiche nella media uomo/donna.

We didn't stop at functionality and reliability, but introduced the concept of functional release: an innovative solution that allows the side release to absorb peak force created by skiing fast on hard snow, large vibrations that could cause the binding to release. It is thanks to this development that we are able to recommend skiing with the binding pre-fitted in a downhill position making it therefore possible for the front and side releases to work in case of a fall. The side and front releases have a fixed calibration and cannot be adjusted, corresponding with an advanced skier with average male/female physical characteristics.



LOW FRICTION

LOW FRICTION

La forza di sgancio dello scarpone non deve essere influenzata dallo skistopper. Il sistema No-Friction permette di togliere attriti e frizioni in caso di sgancio laterale.

The release strength of the ski boot should not be influenced by the ski brake. The No-Friction System allows to remove any friction or rubbing in case of a lateral release.



ZERO AND CLICK

ZERO AND CLICK

La talloniera ha un innovativo sistema a scatto che permette un facile passaggio dalla posizione di salita a quella di discesa, inoltre la talloniera può essere ruotata di 90° permettendo in fase di salita l'appoggio dello scarpone sul piano dello sci migliorando la lunghezza del passo (angolo 0°)

The heel unit has an innovative snap system that allows an easy transition from an uphill (5.7° angle) to a downhill position and can be rotated 90° allowing the boot to rest on the ski when moving uphill improving the length of stride (0° angle).



360° TECHNOLOGY

360° TECHNOLOGY

Un attacco semplice ma che utilizza la sintesi di diverse tecnologie di lavorazione del leggero: forgiatura dell'alluminio, fresatura acciaio/alluminio, stampaggio polimeri speciali, lavorazioni e trattamenti del titanio.

A simple binding which is nevertheless the synthesis of different lightweight processing technologies: aluminium forging, steel/aluminium milling, special polymer molding, titanium processing and treatments.



ROTORIVETED PINS

ROTO-RIVETED PINS

Inseri scarpone del puntale in acciaio temperato con incavo autopulente. Roto rivettatura per ancoraggio stabile e duraturo.

Boot pins of the front unit made of hardened steel with self-cleaning hollow. roto-riveting for a steady and durable anchorage.

TITAN VARIO.2

MOLLA IN TITANIO
TITANIUM SPRING

PIN IN ACCIAIO TEMPRATO ROTORIBATTUTO
ROTO-RIVETED HARDENED STEEL PIN

ALETTE FORGIATE IN ALLUMINIO
FORGED ALUMINIUM JAWS

ALZATACCO CON 3 POSIZIONI
3 POSITION CLIMBING AID

REGOLAZIONE 24 MM
ADJUSTMENT: 24 MM

INNESTO RAMPANTE
CRAMPON ATTACHMENT

LEVA ANTERIORE
BLOCCO/SBLOCCO ATTACCO
IN TECNOPOLIMERO
TECHNOPOLYMER
LOCK/UNLOCK FRONT LEVER

BASE ATTACCO CON CARRELLO SCORREVOLE ELASTICO PER
GARANTIRE SGANCIO LATERALE IN OGNI SITUAZIONE
8MM ELASTIC SLIDER TRACK TO IMPROVE RELEASE STANDARDS

SKISTOPPER CON SISTEMA ANTIFRIZIONE
NO FRICTION MECHANISM
65mm / 78 mm / 85 mm / 94 mm

CAMBIO MODALITA' SALITA-DISCESA FACILE E VELOCE
EASY AND INTUITIVE TO SWITCH FROM UPHILL TOURING TO DOWNHILL
SKIING MODE



ENGLISH VIDEO
 VIDEO ITALIANO

- TITANIUM CORE
- ELASTIC TITANIUM CORE
- STRONG TITANIUM CORE
- INDEPENDENT JAWS
- LOW FRICTION
- 360° TECHNOLOGY
- ZERO AND CLICK
- ROTORIVETED PINS



250 gr



309 gr



TITAN VARIO.2 cod. 40278

The VARIO.2 binding has an innovative toe unit of one simple component in titanium. Elasticity, strength and independence characterise this ultra-lightweight binding. The heel unit offers different solutions improving the quality of release: lateral elasticity till 43°, 8mm elastic slider track, compatible front and side releases.

↓ ↑	Ski brake	NO SKI BRAKE
↓ ↓	Weight	250 gr
↘	Downhill angle	2.8°
↗	Uphill angle	0° 8.7° 10.5°
← →	Heel setting	24 mm
↔	Material	Ergal - Titanium - Steel - Technopolymer
↕	Release	5-7 7-9 9-11



TITAN VARIO.2 + STOPPER

cod. 40279

The VARIO.2 binding has an innovative toe unit of one simple component in titanium. Elasticity, strength and independence characterise this ultra-lightweight binding. The heel unit offers different solutions improving the quality of release: lateral elasticity till 43°, 8mm elastic slider track, compatible front and side releases, no-friction ski brakes.

↓ ↑	Ski brake	mm.65	mm.78	mm.85	mm.94
↓ ↓	Weight	309 gr			
↘	Downhill angle	2.9°			
↗	Uphill angle	5.8° 8.8° 10.6°			
← →	Heel setting	24 mm			
↔	Material	Ergal - Titanium - Steel Technopolymer			
↕	Release	5-7	7-9	9-11	

TITAN VARIO.2 RENTAL cod. 40280

The VARIO.2 RENTAL binding has an innovative toe unit of one simple component in titanium. Elasticity, strength and independence characterise this ultra-lightweight binding. The heel unit offers different solutions improving the quality of release: lateral elasticity till 43°, 8mm elastic slider track, compatible front and side releases.

↓ ↑	Ski brake	NO SKI BRAKE
↓ ↓	Weight	255 gr
↘	Downhill angle	2,8°
↗	Uphill angle	0° 8.7° 10.5°
↔	Heel setting	34 mm
↔ ↕	Material	Ergal - Titanium - Steel -Technopolymer
↔ ↕	Release	5-7 7-9 9-11



TITAN VARIO.2 RENTAL + STOPPER cod. 40277

The VARIO.2 RENTAL binding has an innovative toe unit of one simple component in titanium. Elasticity, strength and independence characterise this ultra-lightweight binding. The heel unit offers different solutions improving the quality of release: lateral elasticity till 43°, 8mm elastic slider track, compatible front and side releases, no-friction ski brakes. Heel setting 34mm.

↓ ↑	Ski brake	mm.65	mm.78	mm.85	mm.94
↓ ↓	Weight	315 gr			
↘	Downhill angle	2.9°			
↗	Uphill angle	5.8° 8.8° 10.6°			
↔	Heel setting	34 mm			
↔ ↕	Material	Ergal - Titanium - Steel Technopolymer			
↔ ↕	Release	5-7 7-9 9-11			



255 gr



315 gr



RAMPANT - COD. 40275

Rampante in alluminio con aggancio standard.
Alloy rampant with standard attachment.

SIZE: 75mm - 86mm - 91mm - 97 mm



VARIO SKI STOPPER - COD. 40283

Nuovo Ski stopper leggerissimo (pesa solo 62gr) e funzionale. Protetto da due brevetti internazionali, i cui punti chiave sono:

1. il tallone dello scarpone poggia su una ruota che accompagna il movimento laterale del tallone durante lo sgancio senza causare alcun attrito. Questo meccanismo non influisce sul valore di sgancio laterale.
2. Leva dello ski stopper con funzione di bloccaggio e alzata.

New lightweight ski brake (it weighs only 62 gr) and functional. Exclusive and patented operating system of the ski stopper.

Key points of the patent:

1. The ski stopper is held down with the heel of the boot by means of a wheel, capable of turning and translating freely. The wheel accompanies the lateral movement of the heel during the release without causing any friction. This mechanism does not affect the lateral release value.
2. Multifunctional locking lever: ski stopper locking system and climbing-aid.

SIZE: 65mm - 78mm - 85mm - 94 mm



MASCHERA MONTAGGIO TITAN
TITAN MOUNTING JIG - Cod. 40270

PLATE VARIO - COD. 40271

Piastra leggerissima (solo 57gr) che consente la regolazione dell'attacco fino a 24 mm. Un carrello scorrevole permette di mantenere costanti gli standard di sgancio.

Really lightweight plate (only 57g) that allows to adjust the size till 24mm. A slider track permits to maintain constant release standards.

VARIO RENTAL PLATE - COD. 40281

Piastra leggerissima (solo 62gr) che consente la regolazione dell'attacco fino a 34 mm. Un carrello scorrevole permette di mantenere costanti gli standard di sgancio.

Really lightweight plate (only 62g) that allows to adjust the size till 34mm. A slider track permits to maintain constant release standards.



ERGAL GARA TITAN PLATE - COD. 40265

60 mm



LACCETTO/COIL LEASH - COD. 40230

Laccetto per fissare lo sci allo scarpone in assenza di skistopper. Con moschettone personalizzato ski trab.

Safety leash to attach the ski to the boot if not equipped with ski brakes (with SKI TRAB customized carabiner).



SKI SKINS

Ski Trab confeziona 4 qualità di pelli autocollanti e gli accessori in grado di soddisfare le esigenze di tutti gli scialpinisti. Le novità funzionali apportate le rendono estremamente apprezzate dai migliori scialpinisti.

Ski Trab factory produces 4 models of self-adhesive ski skins and a range of high quality accessories, capable of meeting all touring skiers' requirements. The best touring skiers greatly appreciate them thanks to the functional innovations introduced.

BRAND 100% MOHAIR SKINS TRADITIONAL HOT MELT GLUE

Tessilfoca mohair 100% che garantisce un'ottima scorrevolezza e una buona tenuta. Confezionata con gancio punta e gancio coda attivo di Ski Trab. Colore pattern SKI TRAB. Sistema collante tradizionale hotmelt. Disponibile anche in rotoli di diverse larghezze.

100% mohair climbing skins that guarantee excellent slide and good grip. Complete with Ski Trab active tip and tail fasteners. New version with Ski Trab logo in colour. Also available in rolls of different widths. Traditional hot melt adhesive system.

MAESTRO.2 cod 21125

⌘ 157/164/171/178

MAGICO.2 cod 21126

⌘ 157/164/171/178

MISTICO Cod. 21122

↔ 157/164/171/178/185

SUPERMAXIMO Cod. 21123

↔ 171/178/185

Features: Attivo top fix+end hook Attivo+skin bag

ROTOLO ROLLS 40 MT Cod. 21108B

↔ 85 / 95 / 105 / 115



MIX 65% MOHAIR SKINS

TRADITIONAL HOT MELT GLUE

Pelle 65% Mohair per un ottimo grip e grande durabilità. Il sistema di fissaggio punta e coda Attivo permette un comodo e veloce modo di bloccaggio pelle sullo sci. Disponibile anche in rotoli di diverse larghezze. *65% Mohair climbing skin for an excellent grip and durability. The Attivo fixing system allows a comfortable and quick fastening of the skin at the tip and tail of the ski. Also available in rolls of different lengths.*

MAXIMO Cod. 21115

⌘ 157/164/171/178/185

SUPERMAXIMO Cod. 21116

⌘ 171/178/185

SINTESI Cod. 21112

⌘ 150/157/164/171/178

ALTAVIA Cod. 21113

⌘ 157/164/171/178/185

STELVIO 76 (GAVIA 76) Cod. 21127

⌘ 150/157/164/171/178

STELVIO 85 (GAVIA 85) Cod. 21128

⌘ 150/157/164/171/178

Features:

Attivo top fix+endhook Attivo+skin bag

ROTOLO - ROLLS MT. 40 Cod. 21022

↔ 35/50/70/75/82/85/92/100/110/120



RACE YELLOW SKINS

TRADITIONAL HOTMELT GLUE

Tessilfoca da gara mohair 100% - studiata per le competizioni per le sue grandi doti di scorrevolezza garantisce ottime performance, confezionata con il gancio punta attivo Ski Trab – leggerissimo e di facile e veloce utilizzo.

100% mohair race climbing skins - designed for competitions it guarantees great performance thanks to the excellent glide, made with Ski Trab active tip fastener – lightweight and quick and easy to use.

GARA WORLD CUP Cod. 21104

⌘ 157 - 164 - 171 cm

SPRINT WORLD CUP Cod. 21124

⌘ 152/162

Features: Attivo top fix +skin bag

MAESTRO.2 GARA Cod. 21125G

⌘ 157 - 164 - 171 - 178 cm

MAGICO.2 GARA Cod. 21126G

⌘ 157 - 164 - 171 - 178 cm

Features: Attivo top fix+endhook Attivo+skin bag

ROTOLO - ROLLS 33 MT Cod. 21108

↔ 60/63/70/75/85/95



GANCIO CODA CON RIVETTI
TAIL HOOK WITH RIVETS
Cod. 22020



1 FILM PROTEZIONE COLLA
1 GLUE PROTECTION FILM
Cod. 22018

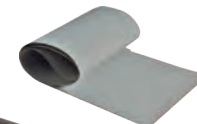

RETE PROTEZIONE
COLLA NYLON
NYLON MESH
GLUE PROTECTION
Cod. 22052



TIRANTE / RUBBER
FREEONE 90 MM
Cod. 22023



GANCIO CODA/END HOOK
ATTIVO.2
Cod. 22062



GANCIO PUNTA + GANCIO CODA
TOP FIX + END HOOK ATTIVO.2
cod 22063



SET RIVETTI
RIVETS SET 100 PC.
Cod. 22034



SET RIVETTI INOX
SET INOX RIVETS 100 PC.
Cod. 22059



GANCIO PUNTA PELLI ATTIVO
ATTIVO TOP FIX
Cod. 22046



GANCIO CODA ATTIVO
ATTIVO TAIL FIX
Cod. 22048



GANCIO PUNTA + CODA
TOP + END FIX ATTIVO
Cod. 22051



TAIL CLIP SET
Cod. 22054



HYBRID CLEANING SPRAY 150 ML
Cod. 22060



COLLANTE
GLUE SKITRAB 65 GR
Cod. 22002



NASTRO COLLANTE
GLUE TAPE

4 mt - 125mm - Cod. 22061
50 mt / 125 mm - Cod. 22017

TIRANTE FONDO
RUBBER TIP NORDIC SKIS
Cod. 22007



VARIO CLIP TOP FIX
Cod. 22065



ANELLO METALLICO
METAL RING
Cod. 22058
70/85 mm



SACCHETTO CUSTODIA
SKI SKIN BAG
Cod. 22064



ATTREZZO RIMUOVI COLLANTE
GLUE SCRAPER
Cod. 22012



ATTREZZO RIMUOVI COLLANTE
BRASS SCRAPER
Cod. 22013



COLLANTE SPRAY
SPRAY GLUE 75 ML
Cod. 22014



GANCIO CODA SQUALO
SHARK END HOOK
Cod. 22053



SCIOLINA PELLI STICK
SKIN WAX STICK
Cod. 22056



SCIOLINA FLUORO PURE
PURE FLUORINATED SKIN WAX
Cod. 22057



SKI POLES

Da alcuni anni la Ski Trab propone dei particolari bastoni da scialpinismo e da sci da fondo. L'esigenza di leggerezza e la sicurezza dello scialpinista sono lo spirito con cui sono stati progettati: materiale leggero e resistente, manopole anatomiche, papere innovative e funzionali e sistemi di allungamento sicuri e pratici.

For some years Ski Trab has been offering some special ski mountaineering and X-country ski poles.

Our poles have been designed combining both the need for lightweight and the touring-skier's safety: light and resistant material, anatomic handles, innovative and functional baskets, safety and practical adjustment systems.



VERTICAL CARBON QC

Cod.41130

Bastone in carbonio per competizioni da scialpinismo. Speciale rinforzo in kevlar per migliorare rigidità e resistenza.

Carbon poles for use in ski mountaineering races. Special Kevlar reinforcement to improve stiffness and resistance.

Cod.42010 VERTICAL HANDLE

Cod.42012 VERTICAL STRAP

100% CARBON

Material: 100% Carbon
Strap: Vertical Strap
Handle: Vertical Handle
Basket: Gara QC basket+Widia
Size: 120cm-150cm each 5 cm
Weight: 160 gr 140cm



Cod.42043
BASKET GARA QC



Cod.42062
TIPS+BASKET
ORTLES QC

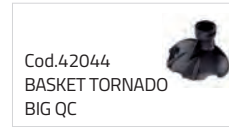

Cod.42044
BASKET TORNADO
BIG QC

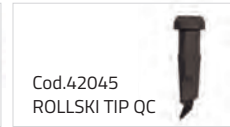

Cod.42045
ROLLSKI TIP QC

KEVLAR
REINFORCEMENT



Cod.42042
BASE AND NUT QC

Cod.42043
BASKET GARA QC



GARA WORLD CUP QC

Cod.41125

Bastone in Ergal leggero con manopola sughero e papera Quick Change

Poles made of light Ergal with cork handles and Quick Change baskets.

Cod.42060 ORTLES CORK HANDLE

Cod.42061 ORTLES CLIP STRAP

GRIP SUPPORT

Material: Ergal Ø 16x0.8
Strap: Ortles Clip strap
Handle: Ortles Cork handle
Basket: Gara QC basket+Widia
Size: 110cm-145 cm each 5 cm
Weight: 185 gr 140cm



Cod.42043
BASKET GARA QC



Cod.42062
TIPS+BASKET
ORTLES QC

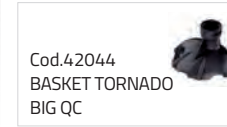

Cod.42044
BASKET TORNADO
BIG QC

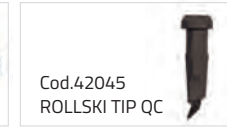

Cod.42045
ROLLSKI TIP QC

ERGALØ 16x0.8



Cod.42042
BASE AND NUT QC

Cod.42043
BASKET GARA QC

GARA Cod.41126

Bastone in Ergal leggero con manopola gomma e papera Gara.

Poles made of light Ergal with rubber handles and Gara baskets.

Cod.42036 RUBBER CLIP HANDLE

Cod.42033 ALP CLIP STRAP

Material: Ergal Ø 16x0.8
Strap: Alp Clip strap
Handle: Rubber clip handle
Basket: Gara basket+Widia
Size: 110cm-145cm each 5 cm
Weight: 185 gr 140cm

ERGALØ 16x0.8



Cod.42034 BASKET GARA





MAESTRO Cod.41127

Bastone in Ergal ovale con manopola Foam e papera Evo con punta widia tonda per utilizzo scialpinistico.
Oval Ergal poles with foam handles and Evo baskets with rounded Widia tips for use in ski touring.

Cod.42030 FOAM CLIP HANDLE
Cod.42033 ALP CLIP STRAP

Material: Ergal Ø 16x0.8 Oval
Strap: Alp Clip strap
Handle: Foam + SG clip handle
Basket: Evo basket + widia tip
Size: 110cm-145 cm each 5 cm
Weight: 210 gr 140cm

EVO BASKET
Cod. 42026

OVAL ERGAL TUBE Ø 16x0.8



MAGICO 16/14 CARBON Cod.41129

Bastone in Ergal e Carbonio/Kevlar 2 pezzi con punta widia tonda per uso scialpinistico .
2-piece Ergal and Carbon Kevlar poles with rounded Widia tips for use in ski touring.

Cod.42030 FOAM- CLIP HANDLE
Cod.42033 ALP CLIP STRAP

Material: Ergal Ø 16x0.8 Carbon Ø 14 +kevlar reinforcements
Strap: Alp Clip strap
Handle: Foam clip handle
Basket: Evo basket
Size: adjustable 105cm-145 cm .
Weight:215 gr.

EVO LOCK



EVO BASKET
Cod. 42026



KEVLAR REINFORCEMENT



ENGLISH VIDEO

VIDEO ITALIANO

ORTLES Cod.41131

Ortles è il bastone due pezzi ad alta affidabilità fisso in discesa e regolabile in salita. Realizzato in carbonio HM ha una rigidità e una forza importanti.
Ortles is a reliable two-piece pole fixed in descent and adjustable in ascent. Made from HM carbon it is rigid and very strong.

Cod.42060 ORTLES CORK HANDLE
Cod.42061 ORTLES CLIP STRAP

Material: Carbon Ø 14 + Carbon reinforcements
Strap: Ortles Clip strap
Handle: Ortles Cork handle
Basket: Ortles basket
Size: customised
Weight: 245 gr.



ALU' LOCK

Cod.42062 TIPS+BASKET ORTLES QC



Cod.42043 BASKET GARA QC



Cod.42044 BASKET TORNADO BIG QC



Cod.42062 TIPS+BASKET ORTLES QC



Cod.42042 BASE AND NUT QC



Cod.42045 ROLLSKI TIP QC



STELVIO Cod.41119

Bastone in Ergal regolabile a 2 pezzi con punta widia tonda per uso scialpinistico. Disponibile in due taglie (95-125cm e 115-140cm)
Adjustable 2-piece Ergal poles with rounded Widia tips for use in ski touring. Available in two sizes: 95-125cm and 115-140cm

Cod.42046 FOAM- BORMIO HANDLE
Cod.42047 BORMIO STRAP



ALU' LOCK

Material: Ergal Ø 16 x 0.8 / 14 x 0.8
Strap: Bormio strap
Handle: Bormio Foam handle
Basket: Bormio basket
Size: adjustable 95cm-125 cm and 115-140cm
Weight: 235 gr.

BORMIO basket
cod. 42040



Trekking rubber



Summer basket





GAVIA 16/14 ERGAL

Cod.41099

Bastone 2 pezzi in Ergal con manopola Foam e punta widia tonda con papera uso scialpinistico.
2-piece Ergal poles with foam handles, rounded Widia tips and ski touring baskets.

Cod.42030 FOAM- CLIP HANDLE

Cod.42033 ALP CLIP STRAP

FOAM GRIP SUPPORT

Material: Ergal Ø 16x0.8 +Ergal Ø 14x0.8
Strap: Alp Clip strap
Handle: Foam+SG clip handle
Basket: Evo basket
Size: Adjustable 105cm-145cm
Weight: 275 gr
Colore / Colour:
○ BIANCO
● NERO

EVO LOCK

ERGAL Ø 16x0.8

+ERGAL Ø 14x0.8

EVO BASKET
Cod. 42026



EVO 3.0 Cod.41128

Bastone in Ergal molto robusto con punta widia tonda per uso scialpinistico

Very strong Ergal poles with rounded Widia tips for use in ski touring.

Cod.42036 RUBBER CLIP HANDLE

Cod.42033 ALP CLIP STRAP

FOAM GRIP SUPPORT

Material: Ergal Ø 18x0.8
Strap: Alp Clip strap
Handle: Rubber clip handle
Basket: Evo basket
Size: 110cm-145 cm each 5 cm
Weight: 240 gr 140cm

OVAL ERGAL TUBE Ø 18x0.8

EVO BASKET
Cod. 42026



SPRINT CARBON FOLDABLE Cod.41087

Bastone componibile in 4 pezzi (36 cm) in carbonio molto leggero. Manopola leggera Foam e punta Widia tonda con papera doppio utilizzo (inverno/estate)

Very light foldable 4-piece (36cm) Carbon poles. Light foam handles and rounded Widia tips with dual-purpose ski/trekking baskets (winter/summer).

Cod.42049 SPRINT FOAM HANDLE

Cod.42048 SPRINT STRAP

FOAM GRIP SUPPORT



ALU' LOCK

Material: foldable Carbon 4 pieces
Strap: Sprint strap
Handle: Sprint foam handle
Basket: Bormio basket
Size: adjustable 115cm-135cm (36cm closed)
Weight: 210 gr

FOLDABLE SYSTEM

FOLDABLE
CARBON 4 PIECES

BORMIO basket
cod. 42040



Winter extension



Summer basket



BORMIO 16/14/12

Cod.41090

Bastone 3 pezzi in Ergal con manopola Foam e punta Widia tonda con papera doppio utilizzo (inverno/estate)

3-piece Ergal poles with foam handles, rounded Widia tips and dual-purpose ski/trekking baskets (winter/summer).

Cod.42046 FOAM- BORMIO HANDLE

Cod.42047 BORMIO STRAP

FOAM GRIP SUPPORT

Material: Ergal Ø 16x0.8 +Ergal Ø 14x0.8
+Ergal Ø 12x0.8
Strap: Bormio strap
Handle: Bormio foam handle
Basket: Bormio basket
Size: adjustable 105cm-135 cm (63.5cm closed)
Weight: 235 gr

ALU LOCK

ERGAL Ø 16x0.8

+ERGAL Ø 14x0.8

+ERGAL Ø 12x0.8

BORMIO basket
cod. 42040



Winter extension



Summer basket





HIGH PERFORMANCE GLOVES

Le grandi avventure richiedono guanti sensibili, caldi, precisi, fatti con materiali d'avanguardia. Se invece è la performance che cerchi allora serve leggerezza, velocità, funzionalità. Qualità e specializzazione sono fondamentali anche se l'obiettivo è il semplice comfort. Salita e discesa hanno esigenze diverse che solo un guanto studiato per lo sci Alpinismo può soddisfare. Qualunque sia il tuo stile abbiamo il miglior guanto per te, grazie a 30 anni di esperienza. I guanti skitrab sono progettati e costruiti con Level, marchio di grande qualità. Questo significa ricerca di materiali sempre innovativi come il grafene, shape sagomati sulla tridimensionalità, indice di termicità, design moderno. Solo i guanti migliori passano tutti i nostri test.

Big adventures call for gloves that are sensitive, warm, precise, made from cutting-edge materials. If instead it is performance you are looking for then you need lightness, speed and functionality. Quality and specialisation are essential even if the objective is merely comfort. Ascent and descent have different requirements that only a glove designed especially for ski touring will provide. Whatever your style, we have the best glove for you, thanks to 30 years of experience. SkiTrab gloves are designed and made together with Level, a quality brand. This means research into innovative materials like graphene, 3D shape modelling, warmth index, modern design. Only the best gloves pass all our tests.



 ENGLISH VIDEO

 VIDEO ITALIANO



GARA AERO COD. 27189

Guanto da gara con una buona vestibilità grazie alle dita preformate e buona termicità con la cover a scomparsa in Nylon.
Race glove offering a superior fit thanks to its preformed fingers as well as good warmth due to the roll-away nylon cover.

Shell: 3 Layer Polyester breathable soft shell, windproof
Liner: 100% Greed Fleece on palm + 100% Plan Polyester liner on back
Palm: Goat leather on fingers + Microfiber reinforcement + Nylon fabric
Insulation: Light and warm greed fleece technology
Cuff: Breathable Neoprene
Features: Outside stitching on fingers for better fit + wind and water-resistant cover on back pocket + cuff puller
SIZE: XS - S - M - L - XL - XXL



 WARMTH INDEX
-15°|-5°

 DRY TECHNOLOGY
WINDPROOF
DURABLE WATER RESISTANCE

 INSULATION
LIGHT AND WARM FLEECE
COVER



GARA AERO WMN COD. 27190

Guanto da gara nella versione femminile per adattarsi meglio alle esigenze delle atlete, con ottima vestibilità grazie alle dita preformate. Buona termicità e Cover a scomparsa in Nylon.
Women's race glove designed especially for female athletes with a superior fit thanks to the preformed fingers. Good warmth due to the roll-away nylon cover.

Shell: 3 Layer Polyester breathable soft shell, windproof
Liner: 100% Greed Fleece on palm + 100% Plan Polyester liner on back
Palm: Goat leather on fingers + Microfiber reinforcement + Nylon fabric
Insulation: Light and warm greed fleece technology
Cuff: Breathable Neoprene
Features: Outside stitching on fingers for better fit + wind and water-resistant cover on back pocket + cuff puller
SIZE: XS - S - M - L



 WARMTH INDEX
-15°|-5°

 DRY TECHNOLOGY
WINDPROOF
DURABLE WATER RESISTANCE

 INSULATION
LIGHT AND WARM FLEECE
COVER



GARA PLUS COD. 27194

Guanto da gara e allenamento con ottima vestibilità grazie alle dita preformate. Buona termicità.

Race and training glove with a superior fit thanks to the preformed fingers. Good warmth.

Shell: 3 Layer Polyester breathable soft shell, windproof
Liner: 100% Greed Fleece on palm + 100% Plan Polyester liner on back
Palm: Goat leather on fingers + Microfiber reinforcement + Nylon fabric
Insulation: Light and warm greed fleece technology
Cuff: Breathable Neoprene
Features: Outside stitching on fingers for better fit + cuff puller
SIZE: XS - S - M - L - XL - XXL



WARMTH INDEX
-15° | -10°

DRY TECHNOLOGY
WINDPROOF
DURABLE WATER RESISTANCE

INSULATION
LIGHT AND WARM FLEECE
LIGHT INSULATION



GARA LITE COD. 27191

Guanto da gara leggero con un'ottima traspirabilità; rinforzi in silicone sul palmo per garantire un buon grip sul bastone. Adatto per temperature non troppo rigide.

Lightweight race glove offering excellent breathability, with silicone supports on the palm to guarantee grip; suitable for mild temperatures.

Shell: 3 Layer Polyester breathable soft shell, windproof
Liner: 100% Plan Polyester liner
Palm: Reinforced Microfiber palm + gripping silicone
Insulation: None
Cuff: Anatomic elastic Lycra
Features: Puller on cuff
SIZE: S - M - L - XL

WARMTH INDEX
-10° | 0°

DRY TECHNOLOGY
WATER AND WINDPROOF
ON BACK

INSULATION
NONE



OVERGLOVE GARA PLUS COD. 27193

Copriguanto leggero e compatto ma allo stesso tempo con un'ottima termicità, perfetto da utilizzare sopra il guanto leggero per la discesa.

Overglove that is lightweight and compact, but also very warm, perfect for use over a light glove when skiing.

Shell: 3 Layer Polyester breathable soft shell, windproof
Liner: 100% polyester smooth lining
Palm: 100% Nylon + Silicone printed lycra
Insulation: Polyester soft insulation 140 gr
Cuff: Double layer elastic lycra
Features: Opening palm system + cuff puller + elastic loop fixing system
SIZE: S - M - L



WARMTH INDEX
-28° | -18° with under glove
-23° | -13° alone

DRY TECHNOLOGY
WINDPROOF
DURABLE WATER RESISTANCE

INSULATION
LEVEL SOFT 140 GR



GARA OVERGLOVE WATERPROOF COD. 27176

Copriguanto completamente impermeabile ed antivento per garantire la massima protezione all'acqua, membrana traspirante e rinforzi in silicone sul palmo per un'ottimo grip.

Completely waterproof and windproof overglove to guarantee maximum protection from the wet, breathable membrane and silicone reinforcements on the palm for excellent grip.

Shell: 100% Nylon stretch fabric + high breathable membrane
Liner: None
Palm: 100% Nylon stretch fabric + high breathable membrane + silicone print
Insulation: None
Cuff: 100% Nylon stretch fabric + high breathable membrane + silicone print
Features: Anatomic fit + puller on cuff
SIZE: S - M - L

WARMTH INDEX
-10° | 0°

DRY TECHNOLOGY
WINDPROOF
HIGH DURABLE WATER RESISTANCE

INSULATION
NONE



MAESTRO.2 COD. 27187

Guanto molto confortevole con dita preformate ed ergonomiche e rinforzi in Lycra perfetto sia per la salita che per la discesa. Rinforzi anatomici in pelle sul palmo e sul pollice. Imbottitura in lana svizzera 100% che consente di migliorare la traspirazione per cui la mano risulta sempre asciutta. Polsino in Airprene. Sistema Touch che permette l'utilizzo di schermi touch con guanto indossato. Polsino window watch. *Very comfortable glove with preformed ergonomic fingers and Lycra reinforcements. Perfect for uphill and downhill. Anatomic leather reinforcements on the palm and thumb. 100% Swiss wool padding to enhance breathability for hands that are always dry. Airprene cuff. Touch system so you can use your smartphone without taking it off. Watch check window.*

Shell: 3-Layer Polyester Breathable soft shell + Polyamide elastic material
Liner: Plan Polyester Liner on the back + Polyester Fleece on the palm
Palm: Leather Goat
Insulation: 100% Swiss Wool on the back
Cuff: Polyamide elastic material
Features: Watch check window + cuff puller + original Swiss made wool
SIZE: XS - S - M - L - XL - XXL



WARMTH INDEX
-15°|-5°

DRY TECHNOLOGY
WINDPROOF
DURABLE WATER RESISTANT

INSULATION
100% SWISS WOOL ON BACK



MAGICO.2 COD. 27186

Guanto da scialpinsimo con dita anatomiche e preformate e rivestimento in pelle. Rinforzi in pelle sul palmo ed attorno al pollice che lo rendono oltre che confortevole anche molto resistente. Imbottitura 133gr primaloft Gold per un'alta termicità. Finestra sul polsino per poter leggere l'orologio. Membrana interna che consente un'impermeabilità completa (7000/7000). Certificato Termplus 3000.

Ski touring glove with anatomic, preformed fingers and leather coating. Leather reinforcements on the palm and around the thumb make it both comfortable and very durable. Extremely warm thanks to a 133g Primaloft Gold padding. Watch check window on the cuff. An internal membrane provides a complete waterproofing barrier (7000/7000) and ensures warmth standard of Thermoplus 3000.

Shell: Leather Goat
Liner: 100% Plan Polyester Liner
Palm: Leather Goat
Insulation: 133 gr Primaloft Gold
Cuff: Leather Goat
Features: Leather reinforcements on thumb and palm + cuff puller + weaved elastic fabric + watch check window + Breathable insert, 5 fingers, Thermoplus 3000 certified
Waterproof: 7000/7000
SIZE: XS - S - M - L - XL - XXL



WARMTH INDEX
-23°|-13°

DRY TECHNOLOGY
WINDPROOF
DURABLE WATER RESISTANT

INSULATION
133 gr PRIMALOFT GOLD



K EVO WOOL COD. 27183

Guanto a 5 dita molto caldo e confortevole. Massimo della ricerca quanto a funzionalità, termicità e uso di materiali innovativi. Utilizza una nuova soluzione di isolamento che abbina uno strato di lana e loft soft che consente di avere sempre le mani calde ed asciutte. Polsino con sistema window watch

Very warm and comfortable 5-finger gloves. Cutting-edge research as well as functionality, warmth and innovative materials. Uses a new kind of insulation which combines a layer of wool and Loft Soft for hands that are always warm and dry. Window for smart watch.

Shell: Breathable and WP laminated Polyamide
Liner: 100% Plan Polyester liner
Palm: goat leather palm + goat leather patch reinforcement
Insulation: 100% Wool insulation on the back + soft insulation on the palm
Cuff: 100% Polyester
Features: elastic cuff for easy fit in &out
SIZE: XS - S - M - L - XL - XXL

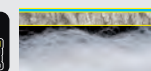

Wool Shell
Soft Insulation Fabrics
Inner Fabrics



WARMTH INDEX
-23°|-13°

DRY TECHNOLOGY
WINDPROOF
DURABLE WATER RESISTANT

INSULATION
LEVEL LOFT +WOOL 140gr.



MITT CABRIO K EVO WOOL COD. 27188

Guanto con un innovativo sistema di isolamento che garantisce ottima termicità e mani sempre asciutte. Al Loft Soft che lo rende un guanto molto caldo e morbido viene aggiunto uno strato di lana che trattiene l'umidità e tiene la mano più asciutta. Sistema cabrio che consente di liberare le dita, incluso il pollice, per avere maggiore manualità. Polsino con window watch.

Glove with an innovative insulation system that guarantees warm, dry hands. Loft Soft padding makes the glove warm and soft with an additional layer of wool to soak up moisture and keep the hand dry. The cabrio system lets you free fingers and thumb to increase dexterity. Window for smart watch.

Shell: Breathable and WP laminated Polyamide
Liner: 100% Plan Polyester liner
Palm: Goat leather palm + goat leather patch reinforcement
Insulation: 100% Wool insulation on the back + soft insulation on the palm
Cuff: 100% Polyester
Features: elastic cuff offers easy on/off flexibility
SIZE: XS - S - M - L - XL - XXL

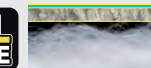

Wool Shell
Soft Insulation Fabrics
Inner Fabrics



WARMTH INDEX
-23°|-13°

DRY TECHNOLOGY
WINDPROOF
DURABLE WATER RESISTANT

INSULATION
LEVEL LOFT +WOOL 140gr.



NORDIC COD. 27185

Guanto con 5 dita con una buona termicità e ottima mobilità della mano grazie alla buona vestibilità e ai materiali molto morbidi, molto confortevole ed adatto sia per lo scialpinismo che per tutte le altre attività invernali quali sci nordico, salita con le ciaspole e nordic walking. *5-finger glove, very warm, excellent dexterity thanks to superior fit and soft fabrics; very comfortable and suitable for ski touring as well as other winter activities like cross-country skiing, snow shoeing and nordic walking.*

Shell: 100% Polyester sublimated
Liner: 100% Plan Polyester Liner
Palm: Reinforced Microfiber palm + silicone
Insulation: Needle insulation back+palm
Cuff: 100% Polyester Sublimated + Polyamide elastic material
Features: Outside stitching + reinforced suede patch + nose cleaner
SIZE: XS - S - M - L - XL - XXL

WARMTH INDEX
-12° | -5°

INSULATION
NEEDLE INSULATION



K SPORT COD. 27195

Guanto molto leggero con cover in Lycra antivento e rinforzi al silicone sul palmo per aumentare il grip sul bastone - tecnologia touch per poter utilizzare smartphone con guanto indossato. *Very lightweight glove with windproof lycra cover and silicone reinforcements on the palm for excellent grip – touch technology to use smartphone without taking it off.*

Shell: Polyester stretch knitted
Liner: Polyester stretch knitted
Palm: microfiber with silicon print for a better grip
Cuff: Cover in nylon high density silver coating
Features: windproof and waterproof cover + reflex piping
SIZE: XS - S - M - L - XL

WARMTH INDEX
-4° | 6°



MITT MAXIMO CLASSIC COD. 27175

Innovativo guanto con dita in polartec e moffola apribile sulle dita che lo rende allo stesso tempo molto traspirante e caldo . Rinforzi in pelle sul palmo ed attorno al pollice che lo rendono oltre che confortevole anche resistente. La cover sulle dita è stata studiata per poter essere messa e tolta in un solo gesto.

Innovative glove with polartec fingers and mitten flap cover that make it ideal for all conditions. Leather reinforcements on the palm and around the thumb make it both comfortable and durable. The cover on the fingers is designed to pull it on and off in one quick, easy movement.

Shell: Very warm Polyester stretch knitted
Liner: Light Polyester lining
Palm: Microfiber reinforced with goat leather
Insulation: None
Cuff: Breathable Neoprene
Features: Polyester windproof and waterproof cover+ fleece
SIZE: XS - S - M - L - XL - XXL

WARMTH INDEX
-16° | -6°

DRY TECHNOLOGY
WINDPROOF.
DURABLE WATER RESISTANT



K LIGHT MITT COD. 27184

Moffola con una buona termicità, molto morbida e perfetta da utilizzare per la discesa, occupa pochissimo spazio ed offre un ottimo comfort. *Very soft, warm mitten, perfect for skiing, taking up little space and offering superb comfort.*

Shell: 100% Polyester fabric
Liner: 100% Plan Polyester liner
Palm: Polyuretan synthetic leather with Polyester base
Insulation: Polyester Soft insulation 140 gr
Cuff: 100% Polyester
Features: Reinforced Goat leather patch
SIZE: S - M - L - XL

WARMTH INDEX
-15° | -5°

DRY TECHNOLOGY
WINDPROOF
DURABLE WATER RESISTANT

INSULATION
LEVEL LOFT 140gr.



BACKPACKS AND BAGS

Una linea completa sviluppata intorno ad un innovativo pannello posteriore stampato in 3D con deformazioni differenziate per migliorare il comfort ed il supporto.

Caratterizzato da leggerezza e robustezza ha funzione protettiva e di ventilazione.

Arricchita con tutti i particolari necessari per lo scialpinista è una linea ideale non solo per l'agonista ma anche per lo scialpinismo in generale.

A line designed around an innovative 3D back panel, shaped with differentiated deformation to improve comfort and support. It stands out for its light weight and strength and guarantees protection and ventilation.

This line of backpacks with all the features necessary for the ski mountaineering is ideal not only for athletes but also for ski touring enthusiasts.



 ENGLISH VIDEO

 VIDEO ITALIANO

GARA 2.0 cod. 23083

Zaino per gara ed allenamento rappresenta l'evoluzione dei modelli World Cup e Grande Course. Il pannello posteriore è montato su un telaio elastico per garantire una perfetta vestibilità. Baricentro alto di ispirazione trail per la migliore libertà di movimento. Doppio sistema di trasporto sci, tasca per pala lontano dalla schiena e porta piccozza.

This race and training backpack is an evolution of the previous Grande Course and World Cup ones. The back protector is mounted on an elastic frame to adhere well to the body and for a perfect fit. Trail inspired high barycentre for complete freedom of movement. Double ski carrying system, shovel pocket away from your back, ice axe loop.



GARA
WATER BLADDER 1.5 LT
cod. 23075
GARA BOTTLE
350 or 600 ML
cod. 23073 or 23074

Fabric by

2ND SKI HOLDER
CRAMPON POCKET
ADJUSTABLE SKI HOLDER
ICE AXE LOOP
KEY POCKET
SHOULDER POCKET
WATER BLADDER POCKET
ELASTIC FIXING SYSTEM AT CHEST LEVEL
RIGID FIXING SYSTEM AT NECK LEVEL
SHOVEL AND PROBE POCKET: AWAY FROM BACK
SHOULDER POCKET WITH ZIP
PADDED BACK
FLASK POCKET
MAGNETIC CHEST SYSTEM

CAPACITÀ / CAPACITY: 22LT
TESSUTO / FABRICS: NYLON, POLYESTER, LYCRA
PESO / WEIGHT: 390GR



CRAMPON POCKET
DOUBLE SKI CARRYING SYSTEM
SHOVEL/PROBE POCKET AWAY FROM YOUR BACK
HIGH CAPACITY



MOUNTAIN T2 cod. 23080

Evoluzione diretta degli zaini race mantiene l'originale schienale a V ma abbina una forma più classica ed un volume di carico superiore. Molto funzionale e pratico.

The evolution of the race backpack, maintains the original V-shaped back protector, while adding a more classic shape and extra capacity. Very functional and practical.



GRANDE COURSE
WATER BLADDER 1.5 LT
cod. 23076
GARA BOTTLE
350 or 600 ML
cod. 23073 or 23074

2ND SKI HOLDER
CRAMPON POCKET
ADJUSTABLE SKI HOLDER
ICE AXE LOOP
KEY POCKET
SHOULDER POCKET
WATER BLADDER POCKET
RIGID FIXING SYSTEM AT NECK LEVEL
PADDED BACK
FLASK POCKET
MAGNETIC CHEST SYSTEM

CAPACITÀ/ CAPACITY: 25LT
TESSUTO / FABRICS: NYLON, POLYESTER, LYCRA
PESO / WEIGHT: 510GR



SPRINT cod. 23081

Calzata ergonomica e volume ridotto all'essenziale per uno zaino in cui riporre lo stretto necessario. Zaino ideale per il running, bike e ski fitness.

Ergonomic fit and reduced volume for a backpack where you can store the bare essentials. Ideal for running, cycling and fitness ski touring.



GARA
WATER BLADDER 1.5 LT
cod. 23075

SKI HOLDER
KEY POCKET
ACCESSORY POCKET
WATER BLADDER POCKET
RIGID FIXING SYSTEM AT NECK LEVEL
PADDED BACK
MAGNETIC CHEST SYSTEM
WALKING POLES DOUBLE SUPPORT

CAPACITÀ/ CAPACITY: 12 LT
TESSUTO / FABRICS: NYLON, POLYESTER
PESO / WEIGHT: 300 GR



ORTLES 26 COD. 23084

Ortles è il nuovo zaino sviluppato per le tue avventure verticali sugli sci. Comfort e funzionalità con un occhio rivolto alla sicurezza. Progettato e realizzato dai professionisti dello sci alpinismo, quello vero.

Ortles is the new backpack developed for your vertical adventures. Comfort and functionality with an eye for safety. Designed and made by true ski touring professionals.



 ENGLISH VIDEO

 VIDEO ITALIANO



EVA BACK PANEL



HELMET NET HOUSING



VENTILATED AIR MESH POCKET

CAPACITÀ/CAPACITY: 26LT
TESSUTO/FABRICS: EVA - NYLON - POLYESTER
PESO/WEIGHT: 880 GR

FEATURES

- SAFETY POCKET WITH RED PULLER, OPENING FROM THE BOTTOM
- EVA BACK PANEL WITH TRANSPARATION HOLES
- DOUBLE ACCESS TO MAIN POCKET
- HELMET NET HOUSING
- VENTILATED AIR MESH POCKET
- SECONDARY POCKET WITH KEY HOOK
- SHAPED WAIST BELT WITH TWO POCKETS
- ASYMMETRICAL WAIST ADJUSTMENT
- DOUBLE LOOP FOR CARABINER
- SKI LOOP AND AXE LOOP
- SIDE SKI HOLDER
- BOTTLE POCKET ON BOTH SHOULDERS
- 2 SIDE POCKETS
- MAGNETIC CHEST SYSTEM
- BOTTOM POCKET
- WATERPROOF ZIP

ORTLES 30 COD. 23085

Ortles è il nuovo zaino sviluppato per le tue avventure verticali sugli sci. Comfort e funzionalità con un occhio rivolto alla sicurezza. Progettato e realizzato dai professionisti dello sci alpinismo, quello vero.

Ortles is the new backpack developed for your vertical adventures. Comfort and functionality with an eye for safety. Designed and made by true ski touring professionals.



 ENGLISH VIDEO

 VIDEO ITALIANO



EVA BACK PANEL



HELMET NET HOUSING



VENTILATED AIR MESH POCKET

CAPACITÀ/CAPACITY: 30LT
TESSUTO/FABRICS: EVA - NYLON - POLYESTER
PESO/WEIGHT: 950 GR

FEATURES

- SAFETY POCKET WITH RED PULLER, OPENING FROM THE BOTTOM
- EVA BACK PANEL WITH TRANSPARATION HOLES
- DOUBLE ACCESS TO MAIN POCKET
- HELMET NET HOUSING
- VENTILATED AIR MESH POCKET
- SECONDARY POCKET WITH KEY HOOK
- SHAPED WAIST BELT WITH TWO POCKETS
- ASYMMETRICAL WAIST ADJUSTMENT
- DOUBLE LOOP FOR CARABINER
- SKI LOOP AND AXE LOOP
- SIDE SKI HOLDER
- BOTTLE POCKET ON BOTH SHOULDERS
- 2 SIDE POCKETS
- MAGNETIC CHEST SYSTEM
- BOTTOM POCKET
- WATERPROOF ZIP

ALTAVIA TRAVEL BAG/ BACKPACK 40 LT - COD. 52075

Borsa / Zaino con spallacci trasformabili in maniglie per il trasporto. Supporto posteriore 3D stampato in eva e nylon, con apertura a tutta lunghezza. 12 tasche oltre allo scomparto principale. Tasca esterna per documenti, vano per le scarpe. Fermo elastico

Bag/Backpack with shoulder straps convertible into carrying handles. Printed back support made of Eva and nylon, with full-length opening. 12 pockets in addition to the main compartment. External pocket for documents, shoe compartment. Elasticated retainer.

CAPACITÀ / CAPACITY: 40LT
TESSUTO / FABRICS: EVA - NYLON
TARAPULIN
PESO / WEIGHT: 1080 GR



POCKETS AND INNER ACCESSORIES



ADJUSTABLE SHOULDERS (3 POSITIONS) CONVERTIBLE INTO CARRYING HANDLES



SOFT SHOULDERS MADE OF NEOPRENE + ELASTIC



EXTERNAL POCKET

SBS ZIP



EXTERNAL POCKET FOR DOCUMENTS



EVA MOULDED BACK PANEL



GARA DUFFLE COD. 52081

Borsa / Zaino con spallacci trasformabili in maniglie per il trasporto. Supporto posteriore 3D stampato in eva e nylon, con apertura a tutta lunghezza. 12 tasche oltre allo scomparto principale. Tasca esterna per documenti, vano per le scarpe. Fermo elastico

Bag/Backpack with shoulder straps convertible into carrying handles. Printed back support made of Eva and nylon, with full-length opening. 12 pockets in addition to the main compartment. External pocket for documents, shoe compartment. Elasticated retainer.

ADJUSTABLE FOAM PADDED SHOULDERS
HELMET POCKET
FOAM PADDED SKI BOOT POCKET
MAIN POCKET
2 POCKETS ON BOTH SIDES

CAPACITÀ / CAPACITY: 40LT
TESSUTO / FABRICS: POLYESTER
PESO / WEIGHT: 1000 GR



----- Helmet Pocket



WAIST BAG WATER BLADDER

COD. 52085

Marsupio borraccia isolata termicamente con diverse tasche per alloggiamento accessori.

Thermal waist pouch flask holder with various pockets for storing accessories.

CAPACITÀ / CAPACITY: 1LT
TESSUTO / FABRICS: POLYESTER
PESO / WEIGHT: 200 GR

WATER BLADDER
KEY POCKET
FOOD POCKET
ELASTIC MESH MAIN POCKET
SILICONE PRINT
POLES SUPPORT



SKI COVER 164/178 cod. 52083

FEATURES

Size: 164/178 - 192 and 205 cm



ATTIVO SKI BAG cod. 52084

FEATURES

Portasci regolabile *Adjustable ski bag.*
Size: 171 - 186 - 205 cm



GARA SKI TROLLEY BAG cod. 52080

FEATURES

Capiente borsa portasci con trolley.
Large ski trolley bag.
Size: 205 cm



ATTIVO SKI BOOT BAG cod. 52082

FEATURES

Borsa scarponi con tasca esterna, piano appoggio rigido.
Ski boot bag with external pocket, stiff bottom.



NECK WARMER - Cod. 52057

FEATURES

Polypropylene



THERMO WAIST BAG cod. 52071

FEATURES

Borraccia isolata termicamente.
Tasca portaoggetti, cintura comfort.
Thermal flask, coin pocket, comfort belt.



XC SEPARATOR

Cod. PR14SEP



SKI STRAP

Cod. PR17LAC_ALP



ELASTIC SKI STRAP 15 mm

Cod. PR14LAC



SKI STRAP 40 mm

Cod. PR14LAC2



HELMETS, GLASSES AND ACCESSORIES

L'uso comune ed indispensabile del casco protettivo necessita per lo scialpinismo soluzioni funzionali e confortevoli. Ski Trab non ha pensato solo agli atleti ma agli sciatori che desiderano comfort e praticità.

The common and indispensable use of a protective helmet needs functional and comfortable solutions for the skitouring. Designed by Ski Trab not only for athletes but also for ski touring enthusiasts in search of comfort and functionality.



 ENGLISH VIDEO

 VIDEO ITALIANO

AERO HELMET

Material:

Shell: Polycarbonate shell with matte finishing

Interior: High density polystyrene

Sizes: M (53-57) and L (58-62)

Colours: Dark Grey

Weight: 290 gr (52-58)

Microfiber foam padding

Size adjustment wheel easy to use

Elastic straps for ski goggles ad lamp

Approval:

Mountaineering (CE EN 12492)

Alpine skiing (CE EN 1077-B)

Cycling (CE EN 1078)

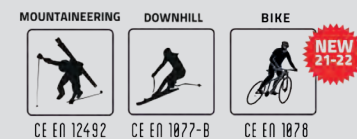

Hollow core technology:

2 EPS (in-mould construction) are assembled to create 6 air canals to ventilate the shell

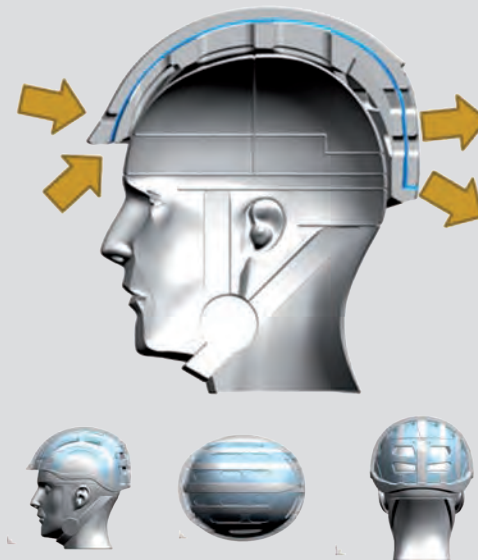

AERO COD. 36023 WHI

Casco molto leggero con un'ottima calzata. Omologato sia per l'alpinismo (CE EN 12492) che per lo sci alpino (CE EN 1077-B) così da rispondere alla normativa ISFM, ha un regolatore di circonferenza testa di veloce e facile utilizzo Atop lacing system. Casco per gli sciatori che vogliono sicurezza a 360°.

Lightweight helmet with an excellent fit. CE approved for ski mountaineering (CE EN 12492), Alpine skiing (CE EN 1077-B), in accordance with ISFM regulations, with an adjustment wheel Atop Lacing System to fit the head that is quick and easy to use. A helmet for skiers who want 360° of safety.



AERO COD. 36023



AERO COD. 36023 BLA



ATTIVO COD. 36030

Casco particolarmente leggero e confortevole, omologato per l'alpinismo (CE EN 12492), ha un regolatore di circonferenza testa di veloce e facile utilizzo. È adatto agli scialpinisti che vogliono sciare in sicurezza, senza rinunciare a confort e praticità. E' possibile applicare la maschera MAXIMO con comodo sistema di fissaggio che la rende particolarmente funzionale.

A very light, comfortable helmet, CE approved (CE EN 12492) for ski mountaineering, with adjustment wheel to fit the head that is quick and easy to use. It is suitable for ski tourers who want to ski in safety, without compromising on comfort and practicality. You can attach MAXIMO goggles with a convenient mounting system that makes it incredibly functional.



Colore / Colour:
○ BIANCO
● NERO

Material:
Shell: external polycarbonate shell
Interior: high density polystyrene
Size: M (52-58) e L (59-62)
Colours: Black and White
Weight: 210 gr
Omologazione / Approval:
Mountaineering (CE EN 12492)



GOGGLES AERO

SIDE VENTILATION
FRONT VENTILATION (5 POINTS)
ADJUSTABLE ELASTIC BAND
4-LAYER FOAM
SHAPE WITH VENTILATION CHANNELS
SPHERICAL LENS WITH HARDENING TREATMENT ON THE OUTER SURFACE
WORLDWIDE PATENTED FOG STOP TECHNOLOGY
WIDE ANGLE
ANTI-SCRATCH DOUBLE LENS
100% UV PROTECTION
MADE IN ITALY

TRANSPARENT
ORANGE
SMOKY



AERO GOGGLES

COD. 36028 TRANSPARENT
COD. 36025 SMOKY
COD. 36027 ORANGE



ALTAVIA SNOW SHOVEL Cod. 31019



FEATURES

SIZE Φ 60/74 cm
Misura pala / Blade size: 24.5 x 28.5 cm
Peso / Weight: 520 gr.

GARA SNOW SHOVEL Cod. 31021



FEATURES

SIZE Φ 50 cm
Misura pala / Blade size: 20x20 cm
Peso / Weight: 282 gr.

SNOW PROBE PRO 240 Cod. 31020



FEATURES

SIZE Φ 240 cm - Φ 10.9 mm
Peso / Weight: 190 gr



KIT PRONTO SOCCORSO
FIRST AID KIT
Cod. 33001



TELO TERMICO
THERMIC BLANKET
Cod. 33004

SPRINT COD. 33023

Lampada a led compatta e leggera, dotata di 800 lumen. Consegnata con adattatore per il casco e una pratica fascia per l'utilizzo sulla testa senza casco.

La lampada emette un fascio di luce potente che permette di sciare con un'ottima visibilità.

Sulla parte superiore della lampada è presente il pulsante di accensione e scelta della modalità di funzionamento: 4 livelli di luminosità (max luminosità – 75% di luminosità – 50% di luminosità - luminosità ridotta) e spenta.

Progettata per resistere nelle condizioni più estreme di utilizzo. Ricaricabile con cavo USB.

Peso: 86gr - Autonomia di 2 ore con luminosità al 50%

Lightweight, compact 800 lumen led light.

Comes with helmet adapter and a practical headband for use without a helmet. The lamp emits a powerful beam of light that permits you to ski with excellent visibility.

The power switch is above the lamp and you can choose from 4 levels of brightness, (maximum, 75%, 50%, reduced) and off. Designed to withstand the most extreme conditions. Rechargeable with USB cable.

Weighs 86g, battery life 2 hours with 50% brightness.



ADHESIVE GOPRO HELMET SUPPORT cod.33024
GOPRO HELMET SUPPORT BUCKLE cod.33028
ELASTIC GOPRO HEADBAND cod.33026

Material:
Light Source: Cree XPG2 R5 LEDx2
Luminous Flux: 800 Lm
4 Intensity Level
Weight: 86 gr
Run Time: 2 h at 400 lm
Removable Battery 1100mAh
Materials: aluminium housing + ABS
USB RECHARGEABLE
POWER INDICATOR
MODE MEMORY FUNCTION
TEMP CONTROL DESIGN
Standard and Gopro buckle
ELASTIC GOPRO HEADBAND
included Cod. 33026



7.4 V - 4400 mAh BATTERY- Cod. 33012
7.4 V - 2200 MAH BATTERY - Cod. 33013
8.4 2A CHARGER - Cod. 33014
3.7 V - 2200 mAh BATTERY 450 LM - Cod. 33015
3.7 V CHARGER - Cod. 33016

GOPRO HELMET BUCKLE



AERO LAMP COD. 33020

Lampada a led compatta e leggera, perfetta per lo sci alpinismo, dotata di 2000 lumen. La lampada emette un fascio di luce potente che permette di sciare con un'ottima visibilità.

Sopra la lampada è presente il pulsante di accensione e scelta della modalità di funzionamento: 4 livelli di luminosità (max luminosità, 75% di luminosità, 50% di luminosità, luminosità ridotta) e spenta. Lo stesso pulsante ha quattro led che indicano lo stato di carica delle celle così da indicare l'autonomia delle batterie.

Progettata per resistere nelle condizioni più estreme di utilizzo

Lightweight, compact 2000 lumen led light, perfect for ski touring.

The lamp emits a powerful beam of light that permits you to ski with excellent visibility. The power switch is above the lamp and you can choose from 4 levels of brightness, (maximum, 75%, 50%, reduced) and off.

The same button has 4 LEDs that indicate the current charge level showing in this way the remaining battery life. Designed to withstand the most extreme conditions.



7.4 V - 4400 mAh BATTERY- Cod. 33012
7.4 V - 2200 MAH BATTERY - Cod. 33013
8.4 2A CHARGER - Cod. 33014
3.7 V - 2200 mAh BATTERY 450 LM - Cod. 33015
3.7 V CHARGER - Cod. 33016

Light Source: 2xCREE XM-L U2 LEDs
Luminous Flux: 2000 Lm
Beam Distance : 200m
4 Intensity Level
Weight: 267 gr
Case Material: 6061-T6 Aluminium Alloy
Water resistance: IP66
Impact resistance: 1M
Run Time: 3 h at 2200 lm
Removable Battery, Head Band
Material: CNC-machined, Aluminium 6061-T6
Aluminum alloy housing, anodized abrasion resistant finishing.
Standard and Gopro buckle
ELASTIC GOPRO HEADBAND
included Cod. 33026



ADHESIVE GOPRO HELMET SUPPORT
cod.33024

GOPRO HELMET BUCKLE
cod.33028

ELASTIC GOPRO HEADBAND
cod.33026



BEANIE GARA COD. 85151

Cappellino con caratteristici colori Ski trab con stampa sublimata - i colori sono particolarmente brillanti - in Lycra con interno in light pile - perfetto anche da utilizzare come sottocasco.

Innovative beanie using new Ski Trab Beanie in classic Ski Trab colours with sublimated print - the colours are particularly bright - in lycra with a light fleece lining - perfect for wearing under a helmets

Material: 80% Polyester - 20% Elastane

BAND GARA COD. 85152

Fascia con caratteristici colori Ski trab con stampa sublimata - i colori sono particolarmente brillanti - in Lycra con interno in light pile - perfetta anche da utilizzare come sottocasco

Headband in classic Ski Trab colours with sublimated print - the colours are particularly bright - in lycra with a light fleece lining - perfect for wearing under a helmet.

Material: 80% Polyester - 20% Elastane

BEANIE GARA HIGH MOUNTAIN

COD. 85154

Berretto in Lycra foderato in caldo pile per garantire un'ottima termicità Lycra beanie with fleece lining for extra warmth.

Material: 82% Polyamide - 18% Elastane



BEANIE GARA GRAN COURSE

COD. 85153

Cappellino con caratteristici colori Ski trab con grafica transfer 3D e con interno 3D fleece - i colori sono particolarmente brillanti

Beanie in classic Ski Trab colours with 3D graphic transfer and 3D fleece lining - extra bright colours

Material: 50% Polyamide - 39% Polyester - 11% Elastane



Colore / Colour:

- 01
- 02



Colore / Colour:

- 01
- 02



Colore / Colour:

- 01
- 02

BAND GARA HIGH MOUNTAIN

COD. 85155

Fascia in Lycra con interno doppio strato in pile, molto calda Lycra headband with double layer fleece lining, very warm

Material: 82% Polyester - 18% Elastane



BAND GARA GRAN COURSE

COD. 85156

Fascia con caratteristici colori Ski trab con grafica transfer 3D e con interno 3D fleece - i colori sono particolarmente brillanti

Headband in classic Ski Trab colours with 3D graphic transfer and 3D fleece lining - extra bright colours

Material: 50% Polyamide - 39% Polyester - 11% Elastane



Colore / Colour:

- 01
- 02

ALTAVIA WOOL TECH BEANIE

COD. 85147

Innovativo berretto con nuova tecnologia Ski Trab Wolltech, leggero, caldo e traspirante

Innovative beanie using new Ski Trab Wolltech technology, lightweight, warm and breathable.

Material: 40% wool - 39% polypropylene - 21% polyamide
Available in 3 different colours



Colore / Colour:
● 01
● 02
● 04

ALTAVIA WOOL TECH WARMER

COD. 85148

Innovativo scaldacollo con nuova tecnologia Ski Trab Wolltech, leggero, caldo e traspirante

Innovative neck warmer using new Ski Trab Wolltech technology, lightweight, warm and breathable.

Material: 40% wool - 39% polypropylene - 21% polyamide
Available in 3 different colours

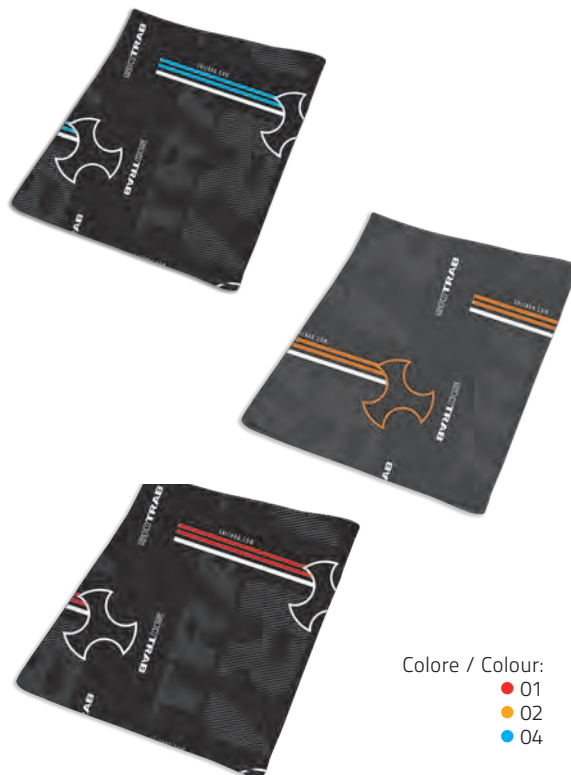

Colore / Colour:
● 01
● 02
● 04

ALTAVIA WOOL TECH TOTAL

COD. 85149

Innovativo passamontagna con nuova tecnologia Ski Trab Wolltech, leggero, caldo e traspirante - è possibile utilizzarlo anche come berretto.

Innovative balaclava using new Ski Trab Wolltech technology, lightweight, warm and breathable - can also be used as a beanie.

Material: 40% wool - 39% polypropylene - 21% polyamide
Available in 3 different colours

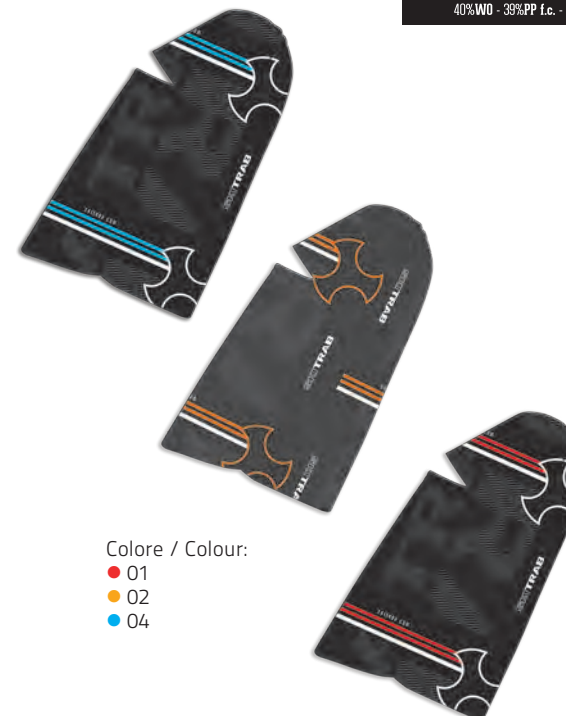

Colore / Colour:
● 01
● 02
● 04

ALTAVIA WOOL TECH BAND

COD. 85150

Innovativa fascia con nuova tecnologia Ski Trab Wolltech, leggera, calda e traspirante

Innovative headband using new Ski Trab Wolltech technology, lightweight, warm and breathable.

Material: 40% wool - 39% polypropylene - 21% polyamide
Available in 3 different colours



Colore / Colour:
● 01
● 02
● 04

BEANIE BRAND COD. 85158

Cappuccia in lana con lavorazione Jacquard con logo Ski Trab con colori a contrasto.

Wool beanie with jacquard pattern and Ski Trab logo in contrasting colours.

Material: 50% wool - 50% Acrylic

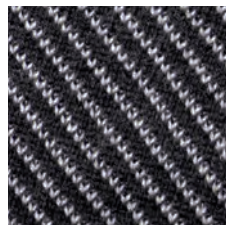

Colore / Colour:

- 01
- 02
- 03



BAND BRAND COD. 85157

Fascia alta in lana con lavorazione Jacquard con interno in pile - scritta grande Ski Trab con colori a contrasto

Wool headband with jacquard pattern and fleece lining - large Ski Trab logo in contrasting colours

Material: 50% wool - 50% Acrylic



Colore / Colour:

- 01
- 02
- 03



BEANIE SUPERMAXIMO 3.0

COD. 85141

Berretto in Lana con punto a grana di riso - interno in pile per garantire un'ottima termicità

Moss stitch wool beanie with fleece lining to guarantee extra warmth

Material: 50% wool - 50% Acrylic

Inner: 100% Polyester

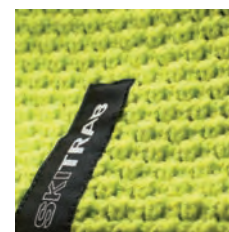

Colore / Colour:

- 01
- 02
- 03
- 05



BAND SUPERMAXIMO 3.0

COD. 85143

Fascia in Lana con punto a grana di riso - interno in pile per garantire un'ottima termicità

Moss stitch wool headband with fleece lining to guarantee extra warmth

Material: 50% wool - 50% Acrylic

Inner: 100% Polyester



Colore / Colour:

- 01
- 02
- 03
- 05



BEANIE STELVIO COD. 85145

Berretto in Lana con lavorazione lana a coste larghe e con interno in pile con colori a contrasto
Ribbed wool beanie with fleece lining and contrasting colours.

Material: 50% wool - 50% Acrylic
Inner: 100% Polyester



Colore / Colour:

- 01
- 02
- 03
- 04



BAND STELVIO COD. 85146

Fascia in Lana con lavorazione lana a coste larghe e con interno in pile con colori a contrasto
Ribbed wool headband with fleece lining and contrasting colours

Material: 50% wool - 50% Acrylic
Inner: 100% Polyester



Colore / Colour:

- 01
- 02
- 03
- 04



BEANIE VARIO COD. 85144

Cappellino in lana monocolore
Monochrome wool beanie

Material: 50% wool - 50% Acrylic



Colore / Colour:

- 01
- 02
- 03



SOCKS ALPIK

COD. 84154 long- COD. 84155 short

La costruzione in maglia rasata ed elasticizzata sul gambale e piede ne favorisce la massima precisione di calzata e un anti-rotolito dinamico.

Le parti del piede di maggior contatto e frizione come, punta, tallone, collo del piede e tendine d'achille sono realizzate in morbida spugna di Merino, seta e Polipropilene che garantiscono massimo confort, buona azione anti-vesciche e favoriscono un microclima ideale per il benessere generale. Leggera, resistente e grazie all'accoppiata della lana Merino e seta con il Polipropilene, è molto coibente traspirante e facile da lavare a 30° come tutti i capi tecnici.

Knitted in stockinette stitch, with elasticised leg and foot, offering a precise fit. They don't roll down your leg at all. The parts of the foot with greater contact and friction like toes, heel, instep and Achilles tendon are made of a soft Merino wool, silk and polypropylene blend that guarantees maximum comfort, protection from blisters providing an ideal microclimate for general well-being. Lightweight, resistant and, thanks to the blending of merino wool and silk with polypropylene, insulating, breathable and easy to wash at 30° like all technical sportswear.

Material: fine merino, silk and polypropylene blend.
SIZE: 35/37 - 38/42 - 41/43 - 44/46





GARA TRACK SUIT M COD. 84167

GARA TRACK SUIT W COD. 84168

Tuta intera da scialpinismo in Lycra Meryl e rinforzi in cordura stretch, zip ykk, zip diagonale ergonomica. Tasche sia interne che esterne per riporre materiale o tessilfoca. Taschina interna per ARTVA con zip.

One-piece racing suit designed for ski mountaineering made of Lycra Meryl with cordura stretch reinforcements, ykk zip, ergonomic diagonal zip. Internal and external pockets to stash material or climbing skins. Internal zipped pocket for avalanche beacon.

Material: Schoeller® ITD ProTec: blend of Carbon yarns and ceramic prints provides a fabric with very high abrasion resistance, especially in the case of high speed crashes.

Lycra, Meryl, cordura stretch, ykk zip

SIZE MEN: S - M - L - XL-XXL

SIZE WOMEN: XS - S - M



GARA TRACK SUIT M 2Pcs COD. 84169

GARA TRACK SUIT W 2Pcs COD. 84170

Tuta due pezzi da scialpinismo in Lycra Meryl e rinforzi in cordura stretch, zip ykk, zip diagonale ergonomica. Tasche sia interne che esterne per riporre materiale o tessilfoca. Taschina interna per ARTVA con zip.

Two-piece suit designed for ski mountaineering made of Lycra Meryl with cordura stretch reinforcements, ykk zip, ergonomic diagonal zip. Internal and external pockets to stash material or climbing skins. Internal zipped pocket for avalanche beacon.

Material: Schoeller® ITD ProTec: blend of Carbon yarns and ceramic prints provides a fabric with very high abrasion resistance, especially in the case of high speed crashes.

Lycra, Meryl, cordura stretch, ykk zip

SIZE MEN: S - M - L - XL-XXL

SIZE WOMEN: XS - S - M



GARA AERO JACKET 2.1 COD. 84162

Giacca impermeabile in Nylon waterproof richiudibile in un piccola e compatta tasca. Cuciture termonastrate.

Waterproof packable jacket made of nylon that folds into a small, compact pocket. Heat-taped seams.

GARA AERO PANT 2.1 COD. 84163

Pantalone impermeabile in nylon con zip laterali. Cuciture termonastrate.

Waterproof nylon pants with lateral zips. Heat-taped seams.

Material: 100% NYLON - WP: 15.000 - MVTR: 15.000

SIZE: XS - S - M - L - XL - XXL

FLEECE BORMIO MAN COD. 84165

FLEECE BORMIO WOMAN COD. 84166

Fleece in Poliestere e Spandex versione uomo e donna.
Men's and women's Polyester and Spandex Fleece.



Colore / Colour:

● MAN

● WOMAN



Material: 90% Polyester, 10% Spandex, breathable insulating dynamic fabric.

SIZE MEN: S - M - L - XL - XXL - XXXL

SIZE WOMEN: XS - S - M

DOWN JACKET BORMIO MAN

COD. 84164

DOWN JACKET BORMIO WOMAN

COD. 84157



FEATURES

Shell: 100 % polyester

Lining: 100 % nylon

Inner padding: white duck feather -10 % - down feather 20 %

WP (Waterproofing): Black Fabric (top) 10.000 WP

MVTR (Moisture vapour transmission rate): 10.000

Grey fabric: no WP no MVTR

Stitch-free baffling for zero drafts

SIZE Women: XS - S - M - L

SIZE Men: XS - S - M - L - XL - XXL



STELVIO JACKET COD. 84158

Collare dal taglio piacevole con pratico cappuccio che non limita la vista o il movimento. Maniche anatomiche con elastico. Due tasche laterali e una frontale.

Pleasant shaped collar with simple, functional and practical hood which does not in any way restrict vision or movement. Anatomically shaped sleeves terminated with elastic hem. Two side zip pockets, one breast pocket.

Material: abrasion-resistant elastic fabric 85 % Nylon-Polyamide (PAD-Polyamide) + 15 % Spandex®-Polyurethane (Polyurethane), DWR Side panels: functional fabric 100% PES-Polyester, 190 g/m2
SIZE Men: XS - S - M - L - XL - XXL

STELVIO PANT COD. 84160

Cintura elastica regolabile con cinturino con fibbia in metallo e chiusure per fissare bretelle. Ampie tasche sulle cosce con cerniere resistenti all'acqua, ad es. per la mappa, una tasca frontale con zip più piccola a destra per skipass o chiavi.

Adjustable elasticated waistband with a strap with a metal buckle and fastenings to attach braces. Roomy thigh pockets with water resistant zips eg. for map, one smaller front zip-pocket on the right for ski pass or keys.

Material: Abrasion resistant brushed fabric (23 % Cordura®-Polyamide + 45 % PAD-Polyamide + 23 % Thermolite®-Polyester + 9 % Polyurethane, DWR) Main 2: Rip-stop stretch fabric (85 % Nylon-Polyamide + 15 % Spandex®-Polyurethane, DWR) Support: Elastic fabric
SIZE Men: XS - S - M - L - XL - XXL

GAVIA JACKET - cod. 84159

Pratico cappuccio che non limita la visibilità ed il movimento. Braccia anatomiche con polsini elastici. Due tasche laterali ed una frontale.
Practical hood which doesn't limit view or movement. Anatomically shaped sleeves with elasticated cuffs. Two side zip pockets and one breast pocket.

Material: abrasion resistant elastic fabric 85 % Nylon-Polyamide (PAD Polyamide) + 15 % Spandex®-Polyurethane (Polyurethane), DWR Side panels: functional fabric 100% PES-Polyester, 190 g/m2
SIZE Women: XS - S - M - L

GAVIA PANT COD. 84161

Pratica regolazione cintura. Due tasche frontali ed una laterale (accessibili anche con imbrago).

Comfortable waist, belt adjustment.

Two front and one side pockets (accessible even when wearing harness).

Material: Abrasion-resistant brushed fabric (23 % Cordura®-Polyamide + 45 % + 23 % Thermolite®-Polyester + 9 % Polyurethane, DWR) Main 2: Cordura®-Polyamide WBL system (46 % Cordura®-Polyamide + 32 % Tactel® + 14 % Lycra®-Polyurethane + 8 % Coolmax®-Polyest
SIZE Women: XS - S - M



T-SHIRT BRAND cod. PR - A02



SKI TRAB CAP cod. PR - A01



SKI+TITAN BINDING DISPLAY

cod PRDEMOSKI



TITAN BINDING WOOD DISPLAY

cod PRPW-40279

(with demo titan key and graphics - without binding)



PENNONE A VELA / SAILFLAG

cod PR-F01

size/misura: 500cm x 80cm
Bandiera in tessuto nautico, struttura interamente in alluminio, gancio di sicurezza per fissare la tenda, borsa per il trasporto con massima resistenza.
Flag made of nautical fabrics, 100% aluminium frame safety hook to fix the flag, highly resistant bag.

BANNER

cod PR11BA

altezza 80cm - height 80cm - (a metro)



durability.



NORDIC SKI

cod PR-CAT1

CATALOGO CATALOGUE
misura/size 20 cm x 20 cm



TOURING SKI

cod PR-CAT2

CATALOGO CATALOGUE
misura/size 20 cm x 20 cm



DISTRIBUTORS 2021/22

AUSTRIA-GERMANY

UHL GÜNTER

Exklusiv Sportartikelvertrieb GmbH
Wieselsdorfer Straße 34 - 8504 Prading
Tel. +43 31852286 - Fax +43 3185228633 - guenter.uhl@aon.at

BULGARIA

NAMASTE LTD BORISLAV DIMITROV

26 b, Arch. Milanov - Sofia
Tel. +35 928669367 - info@namaste-bg.com

CHINA

FUSHUN SNOW YU AN SPORT CULTURE CO. LTD

HUA DA STREET 1-1/1412 - Shun Chen District
Liaoning Province Fushun City
Tel. +86 13252866353 - 251231779@qq.com

FRANCE

NIC-IMPEX SPORTS & OUTDOOR EQUIPMENT

8 rue de bouvieres, Pae des Glaisins - 74940 Annecy Le Vieux
Tel +33 450 571351 - Fax +33 450 677795 - info@nic-impex.com

NORWAY

KÅRVATN HANDELSKOMPANI AS

Karvatn Gard - 6645 Todalen - Tel: +47 979 56 775
gudmund@karvatn.com - www.karvatn.com

SPAIN-ANDORRA

ARTIDA SPORT S.L.

Calle Muntaner 335 PRL 1R - 08190 Barcelona
Tel. +34 934 143423 - Fax +34 934 146421 - info@artida.es

SOUTH KOREA

HIMAZONE

6-19 Gyeongchun-ro - 227beon-gil Guri-si Gyeonggi-do - Korea 11926
Tel +82 31 566 2336 - Fax +82 31 566 2320 - kish@kotis.net

ROMANIA

S.C. OUTDOOR EMOTION S.R.L.

Romania, Baia Mare, Victoriei Street, No.3
Tel. +40 722771267 - conceptfly@yahoo.com

RUSSIA

EXPONENTA LTD

141014 Mytishi box 480 - Tel/fax +7 498 610 31 21
exponenta@inbox.ru - skislava@gmail.com - www.snowshoes.ru

UNITED KINGDOM

GAUSEN&CO LTD

34 Glenilla Rd, London, NW3 4AN
Tel.+44 7769 88 747 - Admin@Gausenco.com

AGENTS 2021/22 WORLDWIDE

CZECHIA-SLOVAKIA-POLAND

JOSEF SIMUNEK

Heydukova 1589/6 - 18000 Praha 8
Tel. +420 604 269045 - josef.simunek@himalaya8000.com

SWITZERLAND

ANCHIERI DAVIDE

Tel. +41 79 158 34 36
Tel. +39 340 555 12 03 - davide.anchieri@gmail.com

USA/CANADA

VARALDI VINCENT

27 Chemin des étoiles - Eastman JOE 1P0 QC Canada
Tel. +1 819 578 4345 - email: vincent.varaldi@gmail.com

AUSTRALIA-NEW ZELAND

HUGH NEWALL

Suite 11/7 Beissel St, Belconnen ACT, Australia, 2617
Tel. +61 432 687 399 - hugh.newall@bokhara-projects.com.au

AGENTS 2021/22 ITALY

LOMBARDIA-PIEMONTE-VALLE D'AOSTA-LIGURIA

SKI TRAB SRL

Via Battaglion Tirano, 6 - 23032 Bormio (SO)
Tel. +39 0342 901650 - Fax +39 0342 905178
info@skitrab.com

ALTO ADIGE-VAL DI FIEMME-VAL DI FASSA

MAURO MADDALOZZO

Mob. 328 0305524 - Fax +39 0439 59106
madservice.ski@gmail.com

TRENTINO-VENETO-FRIULI

MAURIZIO GIORDANI

Tel./Fax +39 0464 490525
Cell. +39 335 6755191 - info@gmountain.it

EMILIA ROMAGNA

LUIGI TABANELLI

Tel. +39 051 6511174 - Fax +39 051 4682776
Cell. +39 335 5412013 - luigitabanelli@interfree.it

LAZIO-UMBRIA-MOLISE-ABRUZZO-MARCHE

CONCETTA DI BIASE

Tel./Fax 0862.917547 - Cell. 339.4468646
pierodibiase@alice.it



SKITRAB

SKITRAB SRL

Via Btg. Tirano, 6
23032 Bormio (SO)
P.IVA 00757150149
www.skitrab.com
info@skitrab.com

 **SKI TRAB**

 **skitrab_srl**